

www.baydarlar.com

MBC®

KESİCİ TAKIM - CUTTING TOOL

"Siz üretirken
biz destek oluyoruz"
"We support
while you produce"



2015-2016

Genel Ürün Kataloğu
General Product Catalogue



Siz üretirken biz destek oluyoruz / We support while you produce

MBC www.baydarlar.com



Siz üretirken biz destek oluyoruz / We support while you produce





Siz üretirken biz destek oluyoruz / We support while you produce

MBC www.baydarlar.com



Misyonumuz / Our Mission

Sürdürülebilir kalkınmayı kendimize yol haritası kabul ederek; çevreye duyarlı, en az maliyetle, paydaşlarımızın isteklerini karşılayan bir şirket olmaktır.

To be a company which recognise sustainable development as a road map to us to meet the demands of our clients with environmentally sensitive with minimal cost.

Vizyonumuz / Our Vision

Toplam kalite felsefesi ile Dünya Sanayisi'ne güvenilir, kaliteli ürün ve hizmet vermektir.

With the philosophy of total quality; serve the World Industrial Estate reliable and high quality products.

Müşteri istek ve ihtiyaçlarını tam olarak anlamak ve karşılamak, kalite yönetim sistemimizin gelişimini ve etkinliğini sağlayarak iç ve dış pazarda rekabet gücümüzü arttırmak, sürekli gelişmek için tüm çalışanların eğitimini ve katılımını sağlamak, ürün kalitemizi arttırmak ve maliyetlerimizi düşürmek.

Understand exactly what the clients requests and needs; provide the development and effectiveness of our quality management system to increase our competitiveness in domestic and international market; to continuous development ensure the training and participation of all employees; improve the products quality and reduce the costs.

Sektörümüzdeki teknolojik gelişmeleri yakından takip etmek ve bu gelişmeleri her alanda uygulamak.

Follow the technological developments in our industry and implement these developments in all areas.



DIŞ KANAL KATERLERİ
EXTERNAL GROOVING
TOOLHOLDERS
Sayfa - Page : 7-11



**T-SİSTEM İÇ ÇAP TORNALAMA
KATERLERİ**
T-SYSTEM INTERNAL TURNING
TOOLHOLDERS
Sayfa - Page : 49-51



İÇ KANAL KATERLERİ
INTERNAL GROOVING
TOOLHOLDERS
Sayfa - Page : 13-16



**M-SİSTEM İÇ ÇAP TORNALAMA
KATERLERİ**
M-SYSTEM INTERNAL TURNING
TOOLHOLDERS
Sayfa - Page : 53-55



**S-SİSTEM DIŞ ÇAP TORNALAMA
KATERLERİ**
S-SYSTEM EXTERNAL TURNING
TOOLHOLDERS
Sayfa - Page : 17-25



ŞAFTLI TARAMALAR
MILLING TOOLS
Sayfa - Page : 57-75



**C-SİSTEM DIŞ ÇAP TORNALAMA
KATERLERİ**
C-SYSTEM EXTERNAL TURNING
TOOLHOLDERS
Sayfa - Page : 27-28



TARAMA KAFALARI
FACE MILLING
Sayfa - Page : 77-91



**T-SİSTEM DIŞ ÇAP TORNALAMA
KATERLERİ**
T-SYSTEM EXTERNAL TURNING
TOOLHOLDERS
Sayfa - Page : 29-36



FREZELEME TAKIMLARI
FACE MILLING
Sayfa - Page : 93-95



**M-SİSTEM DIŞ ÇAP TORNALAMA
KATERLERİ**
M-SYSTEM EXTERNAL TURNING
TOOLHOLDERS
Sayfa - Page : 37-39



VİDALI TARAMALAR
SCREW TYPE
Sayfa - Page : 96-98



**S-SİSTEM İÇ ÇAP TORNALAMA
KATERLERİ**
S-SYSTEM INTERNAL TURNING
TOOLHOLDERS
Sayfa - Page : 41-45



U-DRILLER
U-DRILLS
Sayfa - Page : 99-107



**C-SİSTEM İÇ ÇAP TORNALAMA
KATERLERİ**
C-SYSTEM INTERNAL TURNING
TOOLHOLDERS
Sayfa - Page : 47-48



KATERLER-YEDEK PAR.
CUTTING TOOLS-SPARE PARTS
Sayfa - Page : 108-113

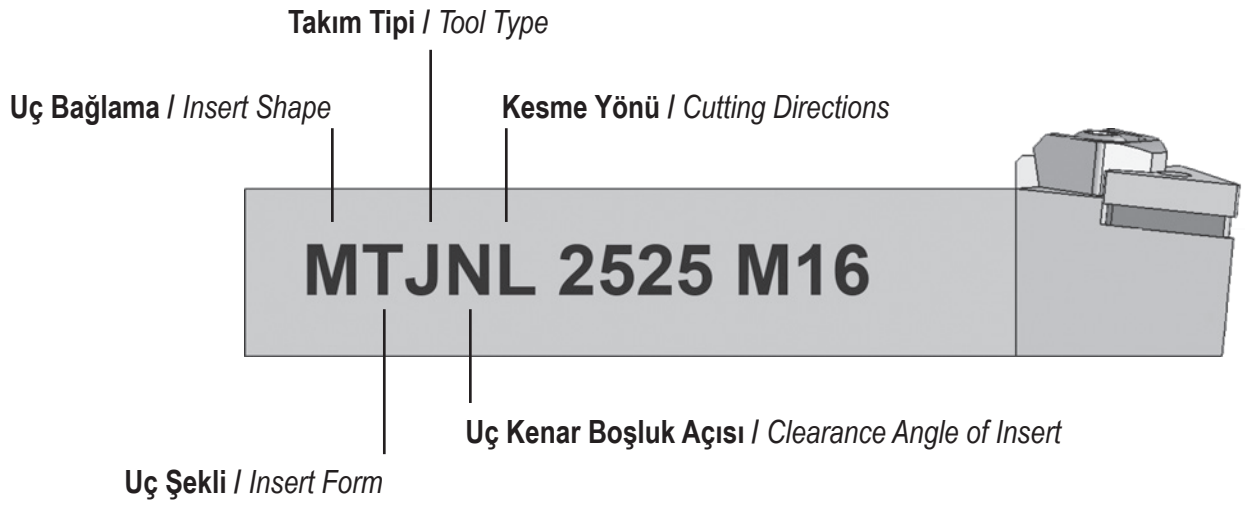

Takım Tipi / Tool Type

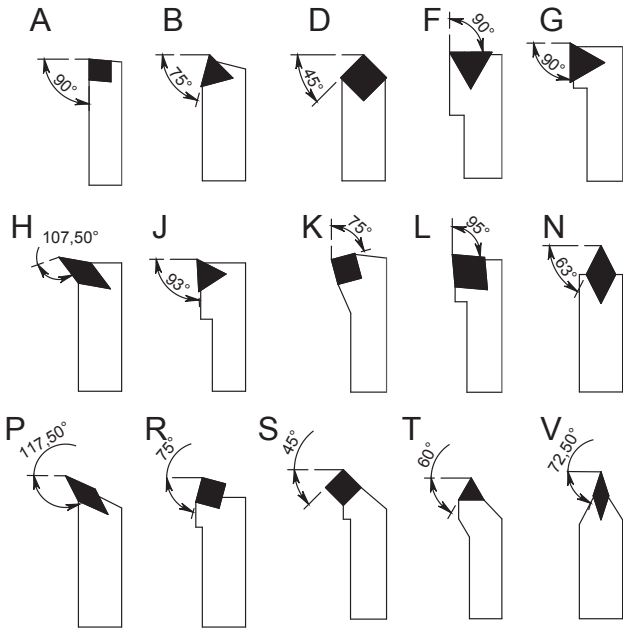

Kesme Yönü / Cutting Directions

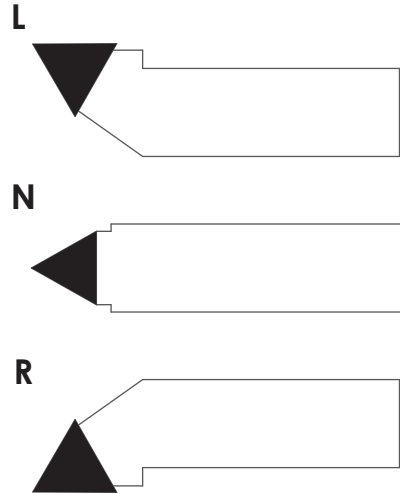

Uç Şekli / Insert Form

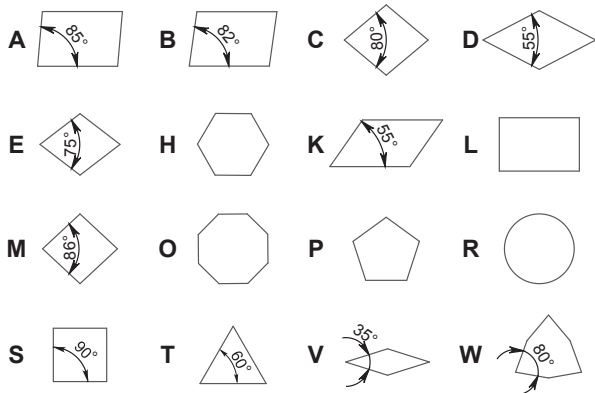

Uç Kenar Boşluk Açısı / Clearance Angle of Insert

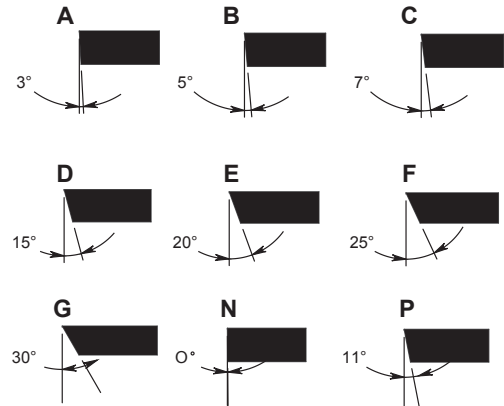

M Sistem - M System

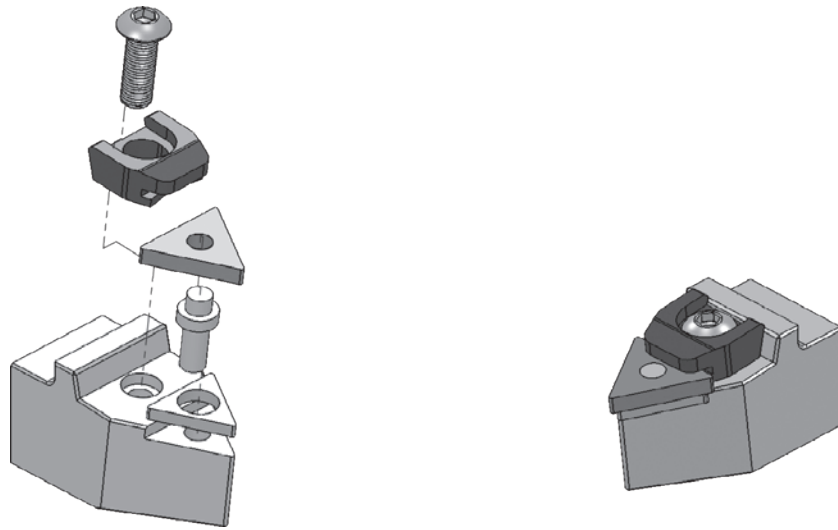

S Sistem - S System

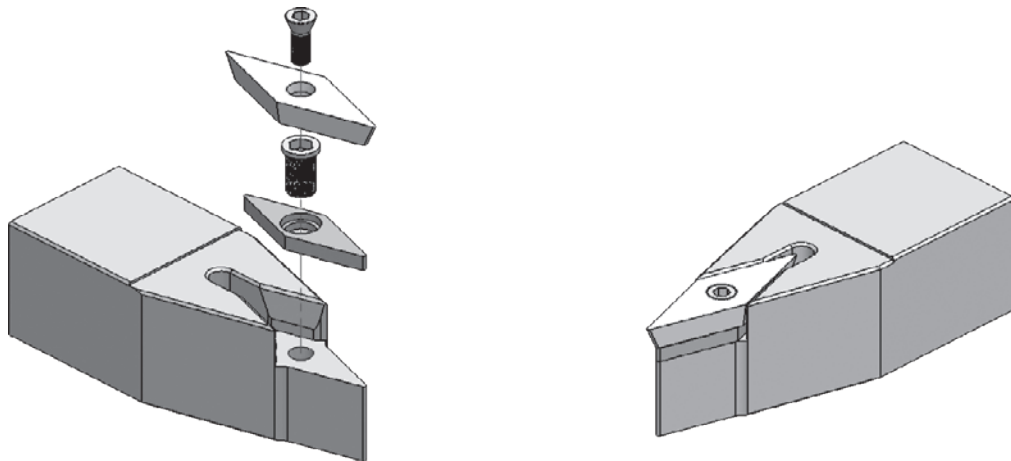



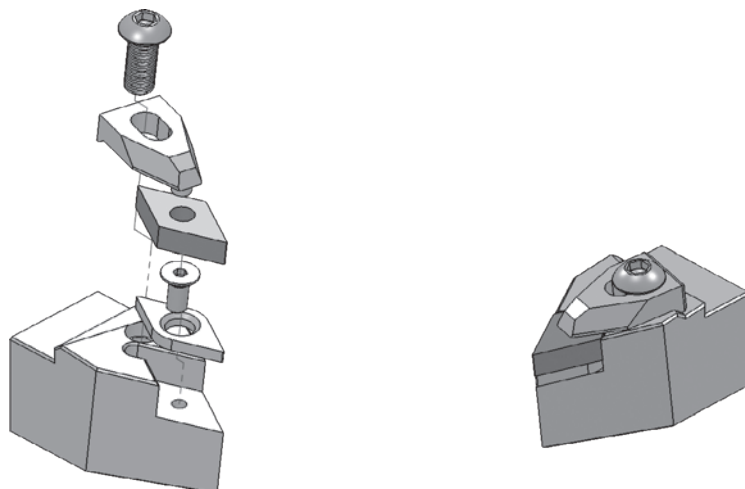





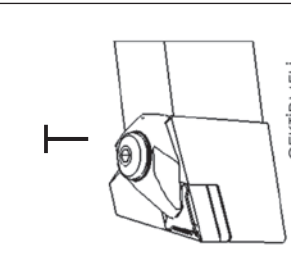
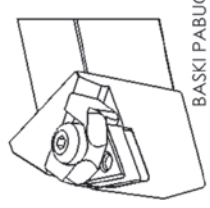
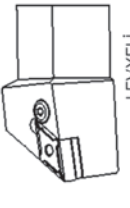























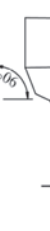

















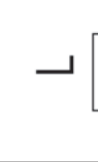



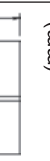



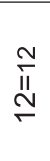
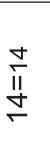

















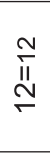
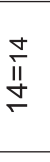
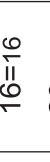



















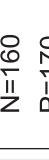
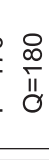
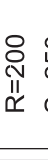















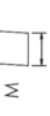

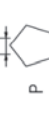

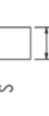
T Sistem - T System

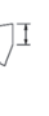

DIŞ ÇAP KATERLERİ İÇİN ISO KODLARI
EXTERNAL TURNING TOOLS ISO CODES

MBC

1	2	3	4	5	6	7	8	9
T	D	J	N	R	20	20	K	15
Uç Bağlama Sistemi Clamping System Klemmsystem	Kesici Uç Tipi Insert form WSP - Form	Kater Tipi Style Werkzeugtyp	Uç Açısı Clearance angle WSP-Freiwinkel	Kater Yönü Holder execution Bearbeitungsrichtung	Şaft Yüksekliği Height of shank Schafthohe	Şaft Genişliği Width of shank Schaffbreite	Takım Boyu Length of holder Werkzeuglänge	Uç Kenar Uzunluğu Length of cutting edge WSP-Größe
 <p>ÇEKTİRMELİ M</p>  <p>BASKI PABUÇLU P</p>  <p>LEVYELİ S</p>  <p>VİDALI</p>	               	               	         	  	                  	                  	                  	                    

7	UÇ RADİJÜSÜ Chamfer or corner radius Planfase oder Eckenradius	R	0 0.2 0.4 0.8 1.2 1.6 2.4 3.2
	SEMBOL	00 02 04 08 12 16 24 32	

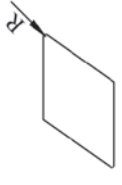

6	UÇ KALINLIĞI Height of cutting edge Schneidkantenhöhe	S	1.59 1.98 2.38 3.18 3.97 4.76 5.56 6.35 7.94 9.52
	SEMBOL	01 T1 02 03 T3 04 05 06 07 09	

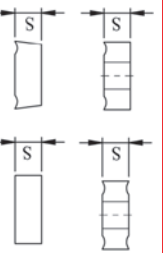

4	KESİCİ UÇ DELİK TİPİ Type of insert Plattentyp	N, F, M, W, Q, R, A, G, T, ÖZEL SPECIAL X
---	--	---

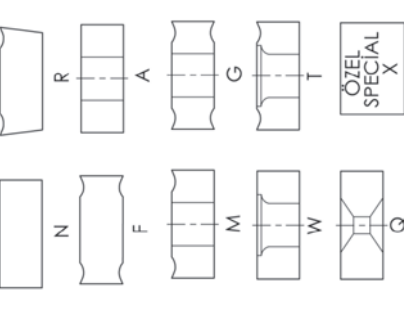

2	UÇ AÇISI Clearance Angle Fräswinkel	5°, 7°, 15°, 20°, 25°, 11°
---	---	----------------------------

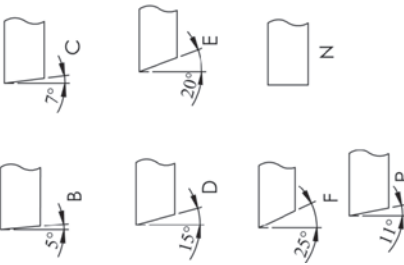

1	KESİCİ UÇ TİPİ Shape Plattentform	C, L, V, D, S, W, E, T, K, R
---	---	------------------------------

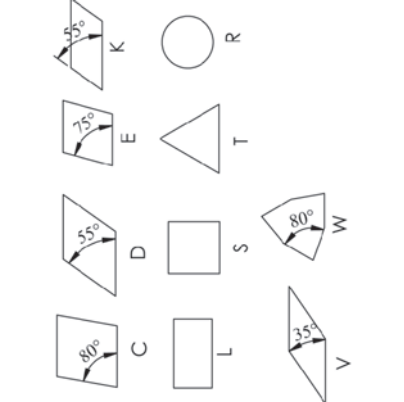

8 H R

7 08

6 06

5 15

4 G

3 M

2 N

1 D

8-9	KESME KENARI ŞEKLİ Insert Forms WSP-Form	UÇ FORMLARI Insert Forms WSP-Form
-----	--	---

5	KESME KENARI UZUNLUĞU Length of Cutting edge Schneidenlänge	C, S, D, T, W, R, V
---	---	---------------------

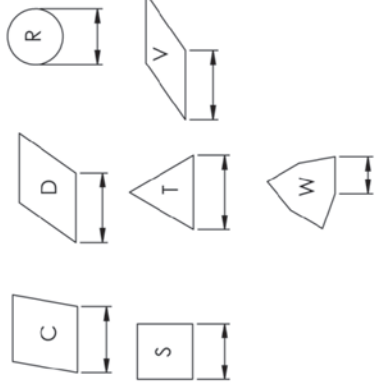

3	UÇ TOLERANSLARI Tolerance Toleranz	m (±)	d (±)
		S (±)	
A	0.005	0.025	0.025
F	0.005	0.013	0.013
C	0.013	0.025	0.025
H	0.013	0.013	0.013
E	0.025	0.025	0.025
G	0.025	0.130	0.025
J	0.005	0.025	0.05 - 0.013
K	0.013	0.025	0.05 - 0.013
L	0.025	0.025	0.05 - 0.013
M	0.08 - 0.18	0.130	0.05 - 0.013
N	0.08 - 0.18	0.025	0.05 - 0.013
U	0.05 - 0.38	0.130	0.08 - 0.025



DIŞ KANAL KATERLERİ - EXTERNAL GROOVING TOOLHOLDERS



DKT-I

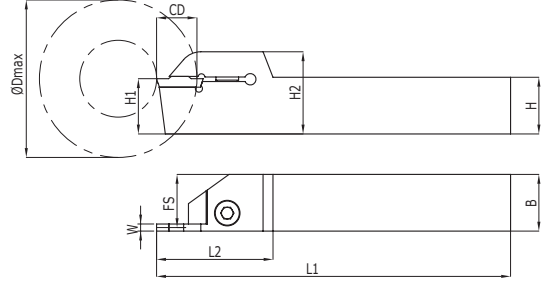

Kesici Uç Uyumluluđu Insert Suitability	Stok Stock		Dmax	W	H	B	FS	L1	L2	H1	H2	CD	Uç Insert	Vida Screw	Anahtar Allen Key
	DGN ISCR	R													
DKT-I -12X12-2C	✓	✓	62	2	12	12	11	90	31	12	24	16	DGN-2	M5X16	A4
DKT-I -16X16-2C	✓	✓	62	2	16	16	15	125	43	16	28.5	16		M6X26	
DKT-I -20X20-2C	✓	✓	62	2	20	20	19	125	43	20	28.5	18	DGN-3	M5X16	
DKT-I -25X25-2C	✓	✓	62	2	25	25	24	150	47	25	35	22		M6X26	
DKT-I -12X12-3C	✓	✓	62	3	12	12	10.5	90	31	12	24	18	DGN-4	M6X26	
DKT-I -16X16-3C	✓	✓	62	3	16	16	14.5	125	43	16	28.5	18			
DKT-I -20X20-3C	✓	✓	62	3	20	20	18.5	125	43	20	28.5	18	DGN-5	M6X26	
DKT-I -25X25-3C	✓	✓	62	3	25	25	23.5	150	47	25	35	22			
DKT-I -32X32-3C	✓	✓	62	3	32	32	30.5	170	47	32	42	22	DGN-5	M6X26	
DKT-I -16X16-4C	✓	✓	62	4	16	16	14	125	43	16	28.5	18			
DKT-I -20X20-4C	✓	✓	62	4	20	20	18	125	43	20	28.5	18	DGN-5	M6X26	
DKT-I -25X25-4C	✓	✓	62	4	25	25	23	150	47	25	35	22			
DKT-I -32X32-4C	✓	✓	62	4	32	32	30	170	47	32	42	22	DGN-5	M6X26	
DKT-I -20X20-5C	x	✓	62	5	20	20	17.5	125	43	20	28.5	18			
DKT-I -25X25-5C	x	✓	62	5	25	25	22.5	150	47	25	35	22	DGN-5	M6X26	
DKT-I -32X32-5C	x	✓	62	5	32	32	29.5	170	47	32	42	22			

DKT-K

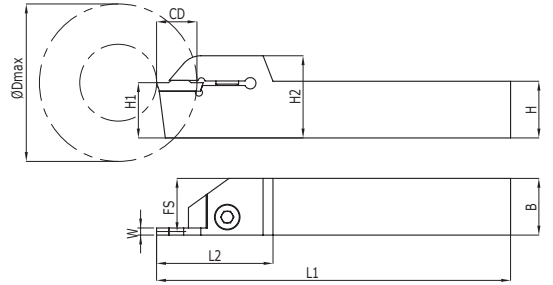

Kesici Uç Uyumluluđu Insert Suitability	Stok Stock		Dmax	W	H	B	FS	L1	L2	H1	H2	CD	Uç Insert	Vida Screw	Anahtar Allen Key
	MGM. KRLY	R													
DKT-K-12X12-2C	✓	✓	62	2	12	12	11	90	31	12	24	16	MGM.2	M5x16	A4
DKT-K-16X16-2C	✓	✓	62	2	16	16	15	125	41	16	28.5	17		M6X26	
DKT-K-20X20-2C	✓	✓	62	2	20	20	19	125	41	20	28.5	17	MGM.3	M5x16	
DKT-K-25X25-2C	✓	✓	62	2	25	25	24	150	45	25	35	18		M6X26	
DKT-K-12X12-3C	✓	✓	62	3	12	12	10.5	90	31	12	24	16	MGM.4	M6X26	
DKT-K-16X16-3C	✓	✓	62	3	16	16	14.5	125	41	16	28.5	21			
DKT-K-20X20-3C	✓	✓	62	3	20	20	18.5	125	41	20	28.5	21	MGM.5	M6X26	
DKT-K-25X25-3C	✓	✓	62	3	25	25	23.5	150	45	25	35	21			
DKT-K-32X32-3C	✓	✓	62	3	32	32	30.5	170	45	32	42	22	MGM.6	M6X26	
DKT-K-16X16-4C	✓	✓	62	4	16	16	14	125	41	16	28.5	21			
DKT-K-20X20-4C	✓	✓	62	4	20	20	18	125	41	20	28.5	21	MGM.6	M6X26	
DKT-K-25X25-4C	✓	✓	62	4	25	25	23	150	45	25	35	21			
DKT-K-32X32-4C	✓	✓	62	4	32	32	30	170	45	32	42	21	MGM.6	M6X26	
DKT-K-25X25-5C	✓	✓	62	5	25	25	22.5	150	45	25	35	22			
DKT-K-32X32-5C	✓	✓	62	5	32	32	29.5	170	45	32	42	22	MGM.6	M6X26	
DKT-K-25X25-6C	✓	✓	62	6	25	25	22	150	45	25	35	23			
DKT-K-32X32-6C	✓	✓	62	6	32	32	29	170	45	32	42	23			

DKT-H

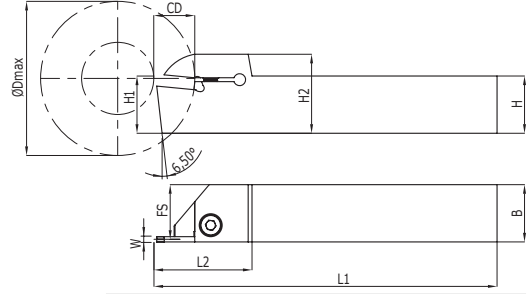

Uç Insert	Vida Screw	Anahtar Allen Key
S229-3	M6X26	A4
S229-4		
S229-5		
S229-3		
S229-4		
S229-5		

Kesici Uç Uyumluluğu Insert Suitability	Stok Stock		Dmax	W	H	B	FS	L1	L2	H1	H2	CD
	R	L										
S229 HRN												
DKT-H-20X20-3C	✓	✓	66	3	20	20	18.5	125	46	20	28.5	22
DKT-H-25X25-3C	✓	✓	66	3	25	25	23.5	150	46	25	35	23
DKT-H-20X20-4C	✓	✓	66	4	20	20	18	125	46	20	28.5	22
DKT-H-25X25-4C	✓	✓	66	4	25	25	23	150	46	25	35	23
DKT-H-20X20-5C	✓	✓	66	5	20	20	17.5	125	46	20	28.5	22
DKT-H-25X25-5C	✓	✓	66	5	25	25	22.5	150	46	25	35	23
DKT-H-32X32-3C	✓	✓	66	3	32	32	30.5	170	46	32	42	24
DKT-H-32X32-4C	✓	✓	66	4	32	32	30	170	46	32	42	24
DKT-H-32X32-5C	✓	✓	66	5	32	32	27.5	170	46	32	42	24

DKT-HK

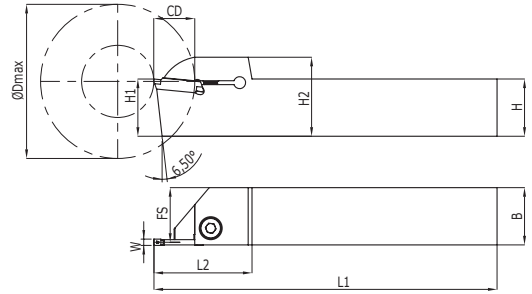

Uç Insert	Vida Screw	Anahtar Allen Key
S224-2	M6X26	A4
S224-3		
S224-4		
S224-3		
S224-4		

Kesici Uç Uyumluluğu Insert Suitability	Stok Stock		Dmax	W	H	B	FS	L1	L2	H1	H2	CD
	R	L										
S224 HRN												
DKT-HK-16X16-2C	✓	✓	62	2	16	16	15	125	43	16	28	18
DKT-HK-20X20-2C	✓	✓	62	2	20	20	19	125	43	20	28	18
DKT-HK-25X25-2C	✓	✓	62	2	25	25	24	150	43	25	35	21
DKT-HK-16X16-3C	✓	✓	62	3	16	16	14.5	125	43	16	28	18
DKT-HK-20X20-3C	✓	✓	62	3	20	20	18.5	125	43	20	28	18
DKT-HK-25X25-3C	✓	✓	62	3	25	25	23.5	150	43	25	35	21
DKT-HK-16X16-4C	✓	✓	62	4	16	16	14	125	43	16	28	18
DKT-HK-20X20-4C	✓	✓	62	4	20	20	18	125	43	20	28	18
DKT-HK-25X25-4C	✓	✓	62	4	25	25	23	150	43	25	35	21
DKT-HK-32X32-3C	✓	✓	62	3	32	32	30.5	170	46	32	42	24
DKT-HK-32X32-4C	✓	✓	62	4	32	32	30	170	46	32	42	24

DKT-TT

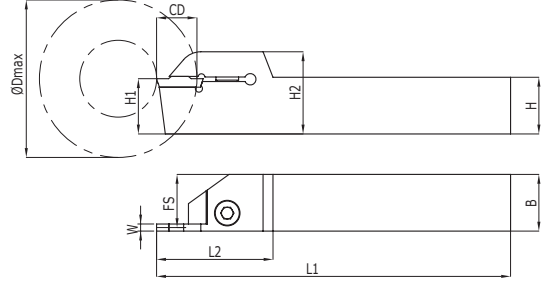

Uç Insert	Vida Screw	Anahtar Allen Key
TD.. 2	M5x16	A4
	M6X26	
	M5x16	
TD.. 3		
	TD.. 4	

Kesici Uç Uyumluluğu Insert Suitability	Stok Stock		TD. TGTC	R	L	Dmax	W	H	B	FS	L1	L2	H1	H2	CD
✓	✓		DKT-TT-12X12-2C			62	2	12	12	11	90	31	12	24	16
✓	✓		DKT-TT-16X16-2C			62	2	16	16	15	125	41	16	28.5	17
✓	✓		DKT-TT-20X20-2C			62	2	20	20	19	125	41	20	28.5	17
✓	✓		DKT-TT-25X25-2C			62	2	25	25	24	150	45	25	35	18
✓	✓		DKT-TT-12X12-3C			62	3	12	12	10.5	90	31	12	24	16
✓	✓		DKT-TT-16X16-3C			62	3	16	16	14.5	125	41	16	28.5	21
✓	✓		DKT-TT-20X20-3C			62	3	20	20	18.5	125	41	20	28.5	21
✓	✓		DKT-TT-25X25-3C			62	3	25	25	23.5	150	45	25	35	21
✓	✓		DKT-TT-32X32-3C			62	3	32	32	30.5	170	45	32	42	22
✓	✓		DKT-TT-16X16-4C			62	4	16	16	14	125	41	16	28.5	21
✓	✓		DKT-TT-20X20-4C			62	4	20	20	18	125	41	20	28.5	21
✓	✓		DKT-TT-25X25-4C			62	4	25	25	23	150	45	25	35	21
✓	✓		DKT-TT-32X32-4C			62	4	32	32	30	170	45	32	42	21

DKT-ZCC2

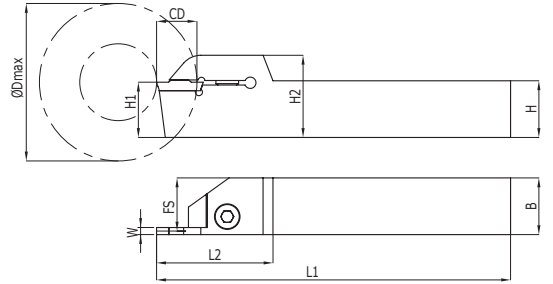

Uç Insert	Vida Screw	Anahtar Allen Key
Z.T.D 3	M6X26	A4
Z.T.D 5		

Kesici Uç Uyumluluğu Insert Suitability	Stok Stock		ZCC Z.T.D	R	L	Dmax	W	H	B	FS	L1	L2	H1	H2	CD
✓	✓		DKT-ZCC-20X20-3C			62	3	20	20	19	125	41	20	28.5	21
✓	✓		DKT-ZCC-25X25-3C			62	3	25	25	24	150	45	25	35	21
✓	✓		DKT-ZCC-20X20-4C			62	4	20	20	18.5	125	41	20	28.5	21
✓	✓		DKT-ZCC-25X25-4C			62	4	25	25	23.5	150	45	25	35	21
✓	✓		DKT-ZCC-20X20-5C			62	5	20	20	18	125	41	20	28.5	21
✓	✓		DKT-ZCC-25X25-5C			62	5	25	25	23	150	45	25	35	21
✓	✓		DKT-ZCC-32X32-5C			62	5	32	32	30	170	45	32	42	23

DIŞ KANAL KATERLERİ EXTERNAL GROOVING TOOLHOLDERS

MBC

DKT-H360

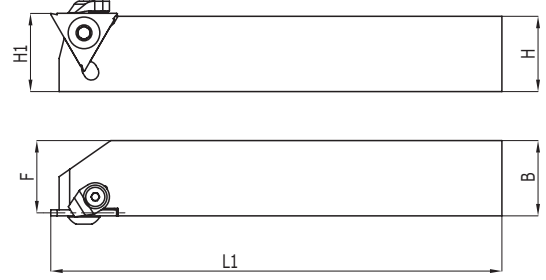

Kesici Uç Uyumluluğu Insert Suitability	Stok Stock	H1	H	B	F	L1	L2	λS	Y0	Uç Insert	Vida Screw	Pabuç Clamp	Vida Screw	Anahtar Torx Key	Anahtar Allen Key
HRN S312															
DKT-H360 20X20 1C	✓	20	20	20	19.5	125	-	0	0	S312-1	M5X12 A3	C110105	M4X10	T15	A3
DKT-H360 20X20 2C	✓	20	20	20	19	125	-	0	0	S312-2					
DKT-H360 20X20 3C	✓	20	20	20	18.5	125	-	0	0	S312-3					
DKT-H360 20X20 4C	✓	20	20	20	18	125	-	0	0	S312-4					
DKT-H360 25X25 1C	✓	25	25	25	24.5	150	-	0	0	S312-1					
DKT-H360 25X25 2C	✓	25	25	25	24	150	-	0	0	S312-2					
DKT-H360 25X25 3C	✓	25	25	25	23.5	150	-	0	0	S312-3					
DKT-H360 25X25 4C	✓	25	25	25	23	150	-	0	0	S312-4					

ALIN KANAL KATERİ

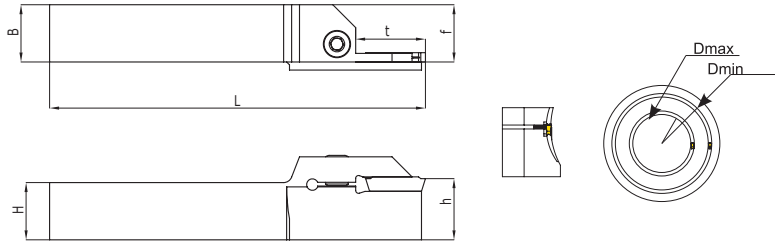

Kesici Uç Uyumluluğu Insert Suitability	Stok Stock	R	L	Dmin	Dmax	H	B	f	L1	h	t max	Uç Insert	Vida Screw	Anahtar Allen Key
MGM KRLY														
AKT-K-25X25-3C R/L (30-40)	✓	X		30	40	25	25	26.7	150	25	17.5	KRLY MGM. 300	M6x26 A4	A4
AKT-K-25X25-3C R/L (35-50)	✓	X		35	50	25	25	26.7	150	25	17.5			
AKT-K-25X25-3C R/L (45-70)	✓	X		45	70	25	25	26.7	150	25	17.5			
AKT-K-25X25-3C R/L (65-105)	✓	X		65	105	25	25	26.7	150	25	17.5			
AKT-K-25X25-3C R/L (100-150)	✓	X		100	150	25	25	26.7	150	25	17.5			
AKT-K-25X25-4C R/L (30-40)	✓	X		30	40	25	25	26.8	150	25	17.5	KRLY MGM. 400		
AKT-K-25X25-4C R/L (35-50)	✓	X		35	50	25	25	26.8	150	25	17.5			
AKT-K-25X25-4C R/L (45-70)	✓	X		45	70	25	25	26.8	150	25	17.5			
AKT-K-25X25-4C R/L (65-105)	✓	X		65	105	25	25	26.8	150	25	17.5			
AKT-K-25X25-4C R/L (100-150)	✓	X		100	150	25	25	26.8	150	25	17.5			
AKT-K-25X25-5C R/L (75-110)	✓	X		75	110	25	25	27	150	25	17.5	KRLY MGM. 500		
AKT-K-25X25-5C R/L (105-150)	✓	X		105	150	25	25	27	150	25	17.5			
AKT-K-25X25-5C R/L (145-200)	✓	X		145	200	25	25	27	150	25	17.5			



Siz üretirken biz destek oluyoruz / We support while you produce



MBC www.baydarlar.com

İÇ KANAL KATERLERİ - INTERNAL GROOVING TOOLHOLDERS



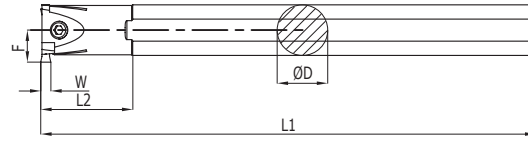



IKT-K

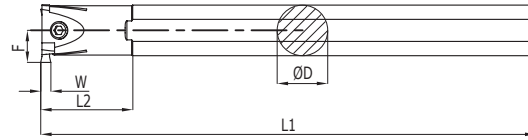

Kesici Uç Uyumluluğu Insert Suitability	Stok Stock									
MGM KRLY		D	D min	F	L1	L2	W	Uç Insert	Vida Screw	Anahtar Allen Key
IKT K 16 2C	✓	16	20	12	180	25	2	MGM.-2	M4X12	A3
IKT K 20 2C	✓	20	25	14	200	30	2			
IKT K 20 3C	✓	20	25	14.5	200	30	3			
IKT K 20 4C	✓	20	25	14.5	200	30	4			
IKT K 25 2C	✓	25	31	18	250	35	2	MGM.-2	M6X16	A5
IKT K 25 3C	✓	25	32	18.5	250	35	3			
IKT K 25 4C	✓	25	32	18.5	250	30	4			
IKT K 32 2C	✓	32	39	22	300	30	2			
IKT K 32 3C	✓	32	42	25	300	35	3	MGM.-3	M6X16	A5
IKT K 32 4C	✓	32	42	25	300	35	4			
IKT K 40 3C	✓	40	52	30	400	60	3			
IKT K 40 4C	✓	40	52	30	400	60	4			
IKT K 40 5C	x	40	52	30	400	60	5	MGM.-5	M6X16	A5
IKT K 32 5C	✓	32	42	25	300	35	5			

IKT-I



Kesici Uç Uyumluluğu Insert Suitability	Stok Stock									
DGN. ISCR		D	D min	F	L1	L2	W	Uç Insert	Vida Screw	Anahtar Allen Key
IKT I 20 2C	✓	20	25	14	200	30	2	DGN.-2	M4X12	A3
IKT I 20 3C	✓	20	25	14	200	30	3			
IKT I 20 4C	✓	20	25	14	200	30	4			
IKT I 25 2C	✓	25	32	18.5	250	40	2	DGN.-2	M6X16	A5
IKT I 25 3C	✓	25	32	18.5	250	40	3			
IKT I 25 4C	✓	25	32	18.5	250	40	4			
IKT I 32 2C	✓	32	41	24.5	300	45	2			
IKT I 32 3C	✓	32	41	24.5	300	45	3	DGN.-3	M6X16	A5
IKT I 32 4C	✓	32	41	24.5	350	45	4			

IKT-HK

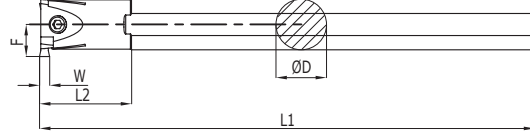

Kesici Uç Uyumluluğu Insert Suitability	Stok Stock	D	D min	F	L1	L2	W	Uç Insert	Vida Screw	Anahtar Allen Key
HRN S224										
IKT HK 20 2C	✓	20	25	14	200	30	2	S224-2	M4X12	A3
IKT HK 20 3C	✓	20	25	14	200	30	3	S224-3		
IKT HK 20 4C	✓	20	25	14	200	30	4	S224-4		
IKT HK 25 2C	✓	25	33	19	250	40	2	S224-2	M6X16	A5
IKT HK 25 3C	✓	25	33	19	250	40	3	S224-3		
IKT HK 25 4C	✓	25	33	19	250	40	4	S224-4		
IKT HK 32 2C	✓	32	40	23	300	45	2	S224-2		
IKT HK 32 3C	✓	32	40	23	300	45	3	S224-3		
IKT HK 32 4C	✓	32	40	23	300	45	4	S224-4		

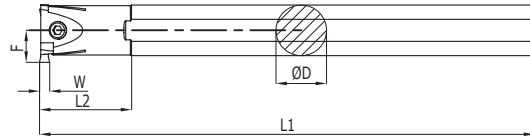

IKT-H

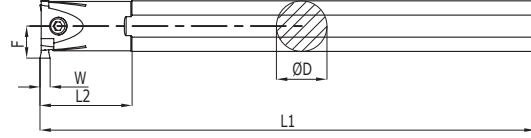

Kesici Uç Uyumluluğu Insert Suitability	Stok Stock	D	D min	F	L1	L2	W	Uç Insert	Vida Screw	Anahtar Allen Key
HRN S229										
IKT H 25 3C	✓	25	34	20.5	250	40	3	S229-3	M6X16	A5
IKT H 25 4C	✓	25	34	20.5	250	40	4	S229-4		
IKT H 25 5C	✓	25	34	20.5	250	40	5	S229-5		
IKT H 32 3C	✓	32	43	26	300	45	3	S229-3		
IKT H 32 4C	✓	32	43	26	300	45	4	S229-4		
IKT H 32 5C	✓	32	43	26	300	45	5	S229-5		
IKT H 40 3C	✓	40	52	30	400	60	3	S229-3		
IKT H 40 4C	✓	40	52	30	400	60	4	S229-4		
IKT H 40 5C	✓	40	52	30	400	60	5	S229-5		

IKT-ZCC2



Kesici Uç Uyumluluğu Insert Suitability	Stok Stock									
ZCC Z.T.D		D	D min	F	L1	L2	W	Uç Insert	Vida Screw	Anahtar Allen Key
IKT ZCC 20 3C	✓	20	25	14.5	200	30	3	Z.T.D-3	M4X12	A3
IKT ZCC 25 3C	✓	25	32	18.5	250	35	3			
IKT ZCC 25 4C	✓	25	32	18.5	250	30	4	Z.T.D-4	M6X16	A5
IKT ZCC 32 3C	✓	32	42	25	300	35	3	Z.T.D-3		
IKT ZCC 32 4C	✓	32	42	25	350	35	4	Z.T.D-4		



S-SİSTEM DIŞ ÇAP TORNALAMA KATERLERİ - S-SYSTEM EXTERNAL TURNING TOOLHOLDERS



SVJBR/L

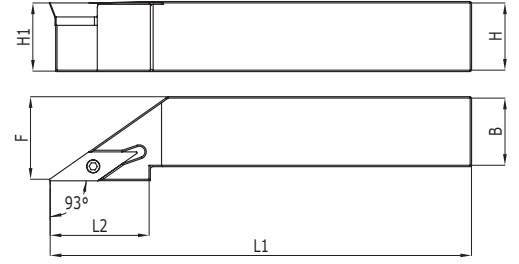

Kesici Uç Uyumluluğu Insert Suitability		Stok Stock		H1	H	B	F	L1	L2	λS	Y0
ISO	R	L									
SVJBR/L 12X12 H11	✓	✓		12	12	20	100	20	20	0	0
SVJBR/L 16X16 H11	✓	✓		16	16	20	100	25	25	0	0
SVJBR/L 20X20 K11	✓	✓		20	20	25	125	35	35	0	0
SVJBR/L 16X16 H16	✓	✓		16	16	20	100	25	25	0	0
SVJBR/L 20X20 K16	✓	✓		20	20	25	125	35	35	0	0
SVJBR/L 25X25 M16	✓	✓		25	25	32	150	40	40	0	0
SVJBR/L 32X32 P16	✓	✓		32	32	40	170	40	40	0	0

Uç Insert	Altılık Shim	Vida Screw	Vida Screw	Anahtar Torx Key
VBM. 1103..			M2,5X7	T08
VBM. 1604..	VB..016	M5X0.5XM3.5	M3,5X14	T15

SVVBN

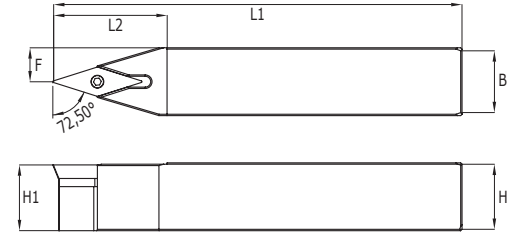

Kesici Uç Uyumluluğu Insert Suitability		Stok Stock		H1	H	B	F	L1	L2	λS	Y0
ISO	R	L									
SVVBN 12X12 H11	✓			12	12	6	100	20	20	0	0
SVVBN 16X16 H11	✓			16	16	8	100	25	25	0	0
SVVBN 20X20 K11	✓			20	20	10	125	35	35	0	0
SVVBN 16X16 H16	✓			16	16	8	100	25	25	0	0
SVVBN 20X20 K16	✓			20	20	10	125	35	35	0	0
SVVBN 25X25 M16	✓			25	25	12.5	150	40	40	0	0
SVVBN 32X32 P16	✓			32	32	16	170	40	40	0	0

Uç Insert	Altılık Shim	Vida Screw	Vida Screw	Anahtar Torx Key
VBM. 1103..			M2,5X7	T08
VBM. 1604..	VB..016	M5X0.5XM3.5	M3,5X14	T15





S-SİSTEM DIŞ ÇAP TORNALAMA KATERLERİ

S-SYSTEM EXTERNAL TURNING TOOLHOLDERS

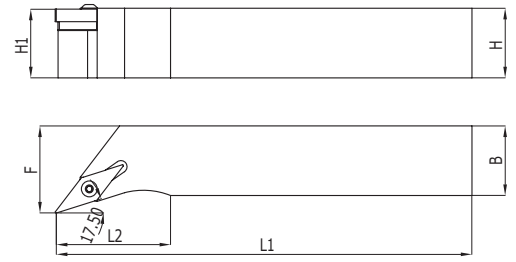
MBC





SVHBR/L

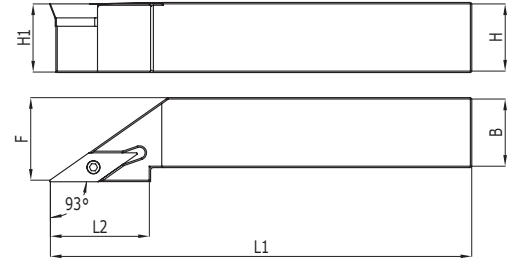

Kesici Uç Uyumluluğu Insert Suitability		Stok Stock												
ISO	R	L	H1 H	B	F	L1	L2	λS	Y0	Uç Insert	Altık Shim	Vida Screw	Vida Screw	Anahtar Torx Key
SVHBR/L 16X16 H11	✓	✓	16	16	20	100	25	0	0	VBM. 1103..			M2.5X7	T08
SVHBR/L 20X20 K11	✓	✓	20	20	25	125	30	0	0					
SVHBR/L 20X20 K16	✓	✓	20	20	25	125	35	0	0	VBM. 1604..	VB..016	M5X0.5XM3.5	M3.5X14	T15
SVHBR/L 25X25 M16	✓	✓	25	25	32	150	40	0	0					
SVHBR/L 32X32 P16	✓	✓	32	32	40	170	40	0	0					

SVJCR/L



Kesici Uç Uyumluluğu Insert Suitability		Stok Stock															
ISO	R	L	H1 H	B	F	L1	L2	λS	Y0	Uç Insert	Altık Shim	Vida Screw	Vida Screw	Anahtar Torx Key			
SVJCR/L 12X12 H11	✓	✓	12	12	20	100	20	0	0	VC.T 1103..			M2,5X7	T08			
SVJCR/L 16X16 H11	✓	✓	16	16	20	100	25	0	0								
SVJCR/L 20X20 K11	✓	✓	20	20	25	125	35	0	0								
SVJCR/L 16X16 H16	✓	✓	16	16	20	100	25	0	0	VC.T 1604..	VC..016	M5X0.5XM3.5	M3,5X11	T15			
SVJCR/L 20X20 K16	✓	✓	20	20	25	125	35	0	0								
SVJCR/L 25X25 M16	✓	✓	25	25	32	150	40	0	0								
SVJCR/L 32X32 P16	✓	✓	32	32	40	170	40	0	0								

SVVCN

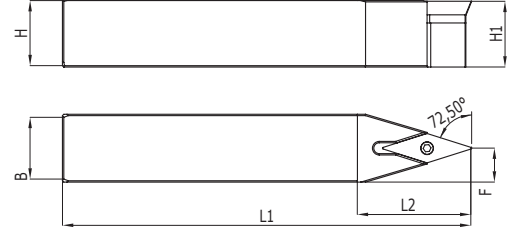

Kesici Uç Uyumluluğu Insert Suitability	Stok Stock	H1	H	B	F	L1	L2	λS	Y0	Uç Insert	Altılık Shim	Vida Screw	Vida Screw	Anahtar Torx Key
ISO														
SVVCN 12X12 H11	✓	12	12	6	100	20	0	0		VC.T 1103..			M2,5X7	T08
SVVCN 16X16 H11	✓	16	16	8	100	25	0	0					M2,5X7	T08
SVVCN 20X20 K11	✓	20	20	10	125	35	0	0					M2,5X7	T08
SVVCN 16X16 H16	✓	16	16	8	100	25	0	0		VC.T 1604..			M3,5X11	T15
SVVCN 20X20 K16	✓	20	20	10	125	35	0	0					M3,5X11	
SVVCN 25X25 M16	✓	25	25	12,5	150	40	0	0			VC..016	M5X0.5XM3.5	M3,5X14	
SVVCN 32X32 P16	✓	32	32	16	170	40	0	0						

SDNCN

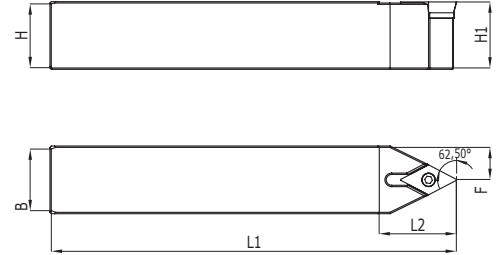

Kesici Uç Uyumluluğu Insert Suitability	Stok Stock	H1	H	B	F	L1	L2	λS	Y0	Uç Insert	Altılık Shim	Vida Screw	Vida Screw	Anahtar Torx Key
ISO														
SDNCN 8X8 H07	✓	8	8	4	100	16	0	0		DC.T 0702..			M2,5X7	T08
SDNCN 10X10 H07	✓	10	10	5	100	16	0	0					M2,5X7	T08
SDNCN 12X12 H07	✓	12	12	6	100	20	0	0					M2,5X7	T08
SDNCN 12X12 H11	✓	12	12	6	100	20	0	0		DC.T 11T3..			M3,5X14	T15
SDNCN 16X16 H07	✓	16	16	8	100	25	0	0		DC.T 0702..			M2,5X7	T08
SDNCN 16X16 H11	✓	16	16	8	100	25	0	0						
SDNCN 20X20 K11	✓	20	20	10	125	35	0	0		DC.T 11T3..			M3,5X14	T15
SDNCN 25X25 M11	✓	25	25	12,5	150	40	0	0					M3,5X14	
SDNCN 32X32 P11	✓	32	32	16	170	40	0	0			DC..011	M5X0.5XM3.5	M3,5X14	





S-SİSTEM DIŞ ÇAP TORNALAMA KATERLERİ

S-SYSTEM EXTERNAL TURNING TOOLHOLDERS

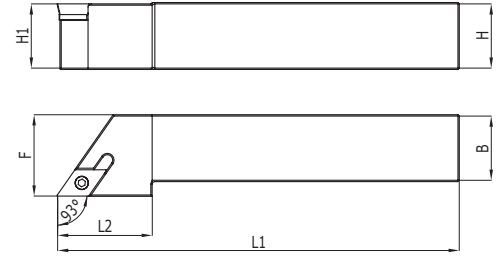
MBC





SDJCR/L

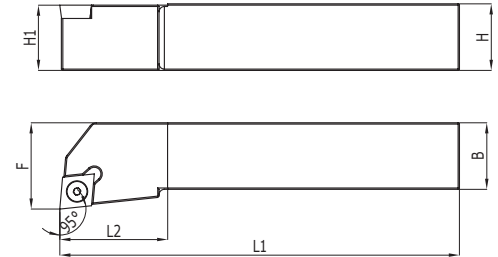

Kesici Uç Uyumluluğu Insert Suitability		Stok Stock												
ISO	R	L	H1 H	B	F	L1	L2	AS	Y0	Uç Insert	Altık Shim	Vida Screw	Vida Screw	Anahtar Torx Key
SDJCR/L 8X8 H07	✓	✓	8	8	10	100	16	0	0	DC.T 0702..			M2,5X7	T08
SDJCR/L 10X10 H07	✓	✓	10	10	12	100	16	0	0					
SDJCR/L 12X12H07	✓	✓	12	12	16	100	20	0	0					
SDJCR/L 16X16 H07	✓	✓	16	16	20	100	25	0	0					
SDJCR/L 16X16 H11	✓	✓	16	16	20	100	25	0	0	DC.T 11T3..	DC..011	M5X0.5XM3.5	M3,5X14	T15
SDJCR/L 20X20 K11	✓	✓	20	20	25	125	35	0	0					
SDJCR/L 25X25 M11	✓	✓	25	25	32	150	40	0	0					
SDJCR/L 32X32 P11	✓	✓	32	32	40	170	40	0	0					

SCLCR/L



Kesici Uç Uyumluluğu Insert Suitability		Stok Stock												
ISO	R	L	H1 H	B	F	L1	L2	AS	Y0	Uç Insert	Altık Shim	Vida Screw	Vida Screw	Anahtar Torx Key
SCLCR/L 8X8 H06	✓	✓	8	8	10	100	16	0	0	CC.T 0602..	—	—	M2.5X7	T08
SCLCR/L 10X10 H06	✓	✓	10	10	12	100	16	0	0					
SCLCR/L 12X12 H06	✓	✓	12	12	16	100	20	0	0					
SCLCR/L 16X16 H06	✓	✓	16	16	20	100	25	0	0					
SCLCR/L 16X16 H09	✓	✓	16	16	20	100	25	0	0	CC.T 09T3..	—	—	M3.5X8	T15
SCLCR/L 20X20 K09	✓	✓	20	20	25	125	35	0	0					
SCLCR/L 25X25 M09	✓	✓	25	25	32	150	40	0	0					
SCLCR/L 16X16 H12	✓	✓	16	16	20	100	25	0	0					
SCLCR/L 20X20 K12	✓	✓	20	20	25	125	35	0	0	CC.T 1204.	CC..12	M6XM4	M4X11	T20
SCLCR/L 25X25 M12	✓	✓	25	25	32	150	40	0	0					
SCLCR/L 32X32 P12	✓	✓	32	32	40	170	40	0	0					

SCNCN

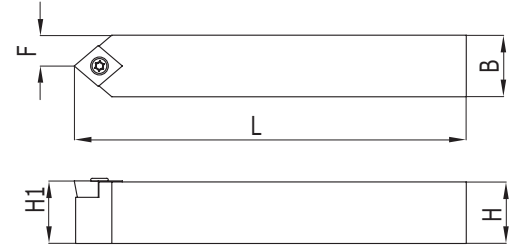

Kesici Uç Uyumluluğu Insert Suitability	Stok Stock	H1	H	B	F	L1	L2	λS	Y0	Uç Insert	Altık Shim	Vida Screw	Vida Screw	Anahtar Torx Key
ISO														
SCNCN 8X8 H06	✓	8	8	4	100	16	0	0		CC.T 0602..			M2,5X7	T08
SCNCN 10X10 H06	✓	10	10	5	100	16	0	0						
SCNCN 12X12 H06	✓	12	12	6	100	20	0	0						
SCNCN 16X16 H09	✓	16	16	8	100	25	0	0		CC.T 09T3..			M3,5X11	T15
SCNCN 20X20 K09	✓	20	20	10	125	35	0	0						
SCNCN 25X25 M12	✓	25	25	12.5	150	40	0	0		CC.T 1204..	CC..012	M6XM4	M4X12	T20

SRGCR/L



Kesici Uç Uyumluluğu Insert Suitability	Stok Stock	H1	H	B	F	L1	L2	λS	Y0	Uç Insert	Vida Screw	Anahtar Torx Key	
ISO	R L												
SRGCR/L 16X16 K08	✓ ✓	16	16	21	125	25	0	0		RC.T 0803..	M3X9	T10	
SRGCR/L 20X20 K08	✓ ✓	20	20	25	125	35	0	0					
SRGCR/L 25X25 M08	✓ ✓	25	25	32	150	40	0	0					
SRGCR/L 20X20 K10	✓ ✓	20	20	25	125	35	0	0		RC.T 10T3..	M4X11	T15	
SRGCR/L 25X25 M10	✓ ✓	25	25	32	150	40	0	0					
SRGCR/L 20X20 K12	✓ ✓	20	20	25	125	35	0	0		RC.T 1204..			
SRGCR/L 25X25 M12	✓ ✓	25	25	32	150	40	0	0					

SRDCN

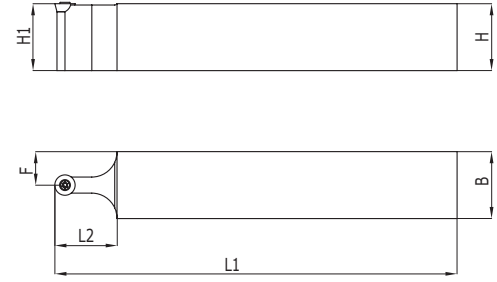

Kesici Uç Uyumluluğu Insert Suitability	Stok Stock	H1 H	B	F	L1	L2	λS	Y0	Uç / Insert, Vida / Screw, Anahtar / Torx Key		
									Uç Insert	Vida Screw	Anahtar Torx Key
SRDCN 16X16 K08	✓	16	16	8	125	25	0	0	RC.T 0803..	M3X9	T10
SRDCN 20X20 K08	✓	20	20	10	125	30	0	0			
SRDCN 25X25 M08	✓	25	25	12.5	150	35	0	0			
SRDCN 20X20 K10	✓	20	20	10	125	30	0	0	RC.T 10T3..	M4X11	T15
SRDCN 25X25 M10	✓	25	25	12.5	150	35	0	0			
SRDCN 20X20 K12	✓	20	20	10	125	30	0	0	RC.T 1204..		
SRDCN 25X25 M12	✓	25	25	12.5	150	35	0	0			
SRDCN 25X25 M16	✓	25	25	12.5	150	35	0	0	RC.T 1604..	M5X12	T20



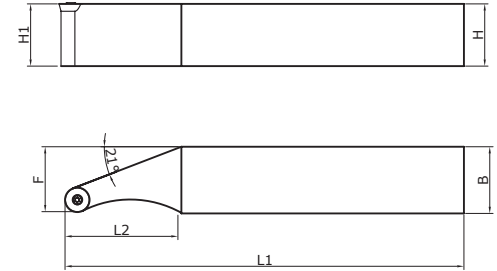

SRHCR/L

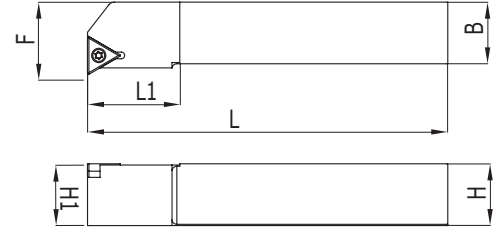

Kesici Uç Uyumluluğu Insert Suitability	Stok Stock		H1 H	B	F	L1	L2	λS	Y0	Uç / Insert, Vida / Screw, Anahtar / Torx Key		
	R	L								Uç Insert	Vida Screw	Anahtar Torx Key
SRHCR/L 16X16 K08	✓	✗	16	16	16	125	25	0	0	RC.T 0803..	M3X9	T10
SRHCR/L 20X20 K08	✓	✗	20	20	20	125	35	0	0			
SRHCR/L 25X25 M08	✓	✗	25	25	25	150	40	0	0			
SRHCR/L 20X20 K10	✓	✗	20	20	20	125	35	0	0	RC.T 10T3..	M4X11	T15
SRHCR/L 25X25 M10	✓	✗	25	25	25	150	40	0	0			
SRHCR/L 20X20 K12	✓	✗	20	20	20	125	35	0	0	RC.T 1204..		
SRHCR/L 25X25 M12	✓	✗	25	25	25	150	40	0	0			



STFCR

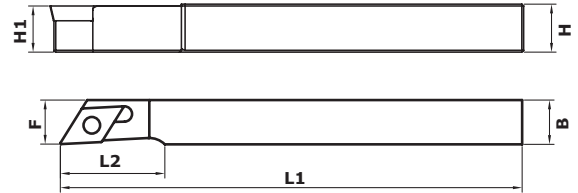

Kesici Uç Uyumluluğu Insert Suitability	Stok Stock														
	ISO	R	L	H1 H	B	F	L1	L2	λS	Y0	Uç Insert	Altılık Shim	Vida Screw	Vida Screw	Anahtar Torx Key
STFCR/L 16X16 H16	✓	✓	16	16	20	100	25	0	0	TC.T 16T3..	—	—	M3.5X11	T15	
STFCR/L 20X20 K16	✓	✓	20	20	25	125	35	0	0		TC..016	M5XM3.5	M3.5X14		
STFCR/L 25X25 M16	✓	✓	25	25	32	150	40	0	0						

DCMT 11 OTOMAT



Kesici Uç Uyumluluğu Insert Suitability	Stok Stock												
	ISO	R	L	H1 H	B	F	L1	L2	λS	Y0	Uç Insert	Vida Screw	Anahtar Torx Key
SDJCR 12X12 K11	✓	✓	12	12	12	125	24	0	0	DC.T 11T3..	M3,5X9	T15	
SDJCL 12X12 K11	✓	✓	12	12	12	125	24	0	0				

S-SİSTEM DIŞ ÇAP TORNALAMA KATERLERİ S-SYSTEM EXTERNAL TURNING TOOLHOLDERS

MBC

SER/L

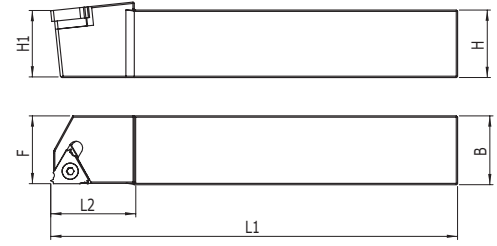

Kesici Uç Uyumluluğu Insert Suitability		Stok Stock															
ISO SER16	R	L	H1	H	B	F	L1	L2	λS	Y0	Uç Insert	Altılık Shim	Vida Screw	Vida Screw	Anahtar Torx Key	Pabuç Clamp	Vida Screw
SER/L 12X12 H11	✓	✓	12	12	15	100	20	-5.5	0		11 ER/L			M2,5X7	T08		
SER/L 16X16 H11	✓	✓	16	16	20	100	25	-5.5	0								
SER/L 16X16 K16	✓	✓	16	16	16	125	30	-5.5	0		16 ER/L	ER/L..016	M5X- 0.5XM3.5	M3,5X14	T15	CK15	M4X12
SER/L 20X20 K16	✓	✓	20	20	20	125	35	-5.5	0								
SER/L 25X25 M16	✓	✓	25	25	25	150	40	-5.5	0								
SER/L 32X32 P16	✓	✓	32	32	32	170	40	-5.5	0								
SER/L 25X25 M22	✓	✓	25	25	25	150	40	-5.5	0		22 ER/L	ER/L..022		M4X15	T20		
SER/L 32X32 P22	✓	✓	32	32	32	150	40	-5.5	0								

SIR

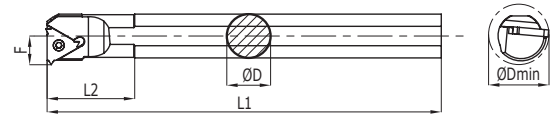

Kesici Uç Uyumluluğu Insert Suitability		Stok Stock															
ISO SIR16	R	L	D	D min	F	L1	L2	λF	YP	Uç Insert	Altılık Shim	Vida Screw	Vida Screw	Anahtar Torx Key	Pabuç Clamp	Vida Screw	
S10K SIR/L 11	✓	✓	10	13	7.5	125	25	-15	-1.5	11 IR/ER	-	-	M2,5X6	T08	-	-	
S12M SIR/L 11	✓	✓	12	15	8.5	150	25	-15	-1.5								
S16-10Q SIR/L 11	✓	✓	16	13	7.5	180	40	-15	-1.5								
S16Q SIR/L 11	✓	✓	16	20	11	180	30	-15	-1.5								
S16Q SIR/L 16	✓	✓	16	20	11	180	30	-15	-1.5								
S20R SIR/L 16	✓	✓	20	25	13	200	35	-15	-1.5								
S25S SIR/L 16	✓	✓	25	32	17	250	35	-15	-1.5	16 IR/ER	IR/ER 016	M5X- 0.5XM3.5	M3,5X11	T15			
S32T SIR/L 16	✓	✓	32	40	21	300	40	-15	-1.5				M3,5X14				
S40V SIR/L 16	✓	✓	40	50	26	400	50	-15	-1.5								
S25S SIR/L 22	✓	✓	25	32	17	250	35	-15	-1.5	22 IR/ER	IR/ER 022		M4X15	T20	CK15	M4X12	
S32T SIR/L 22	✓	✓	32	40	21	300	40	-15	-1.5								
S40V SIR/L 22	✓	✓	40	50	26	400	50	-15	-1.5								
S50W SIR/L 22	✓	X	50	63	35	450	70	-15	-1.5								



Siz üretirken biz destek oluyoruz / We support while you produce

MBC www.baydarlar.com

C-SİSTEM & T-SİSTEM DIŞ ÇAP TORNALAMA KATERLERİ - C-SYSTEM & T-SYSTEM EXTERNAL TURNING TOOLHOLDERS



CTGPR/L

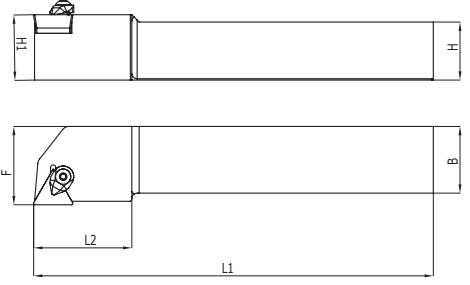

Kesici Uç Uyumluluğu Insert Suitability		Stok Stock							
ISO	R	L	H1-H	B	F	L1	L2	λS	Y0
CTGPR/L 16X16 H16	✓	X	16	16	20	100	30	-6	-6
CTGPR/L 20X20 K16	✓	✓	20	20	25	125	35	-6	-6
CTGPR/L 25X25 M16	✓	✓	25	25	32	150	40	-6	-6
CTGPR/L 25X25 M22	✓	✓	25	25	32	150	40	-6	-6

Uç Insert	Altık Shim	Vida Screw	Pabuç Clamp	Vida Screw	Anahtar Allen Key
TP.. 1603..	-	-	-	M5X12	A4
TP.. 2204..	-	-	TP22	M6X22	A5

CKJNR/L

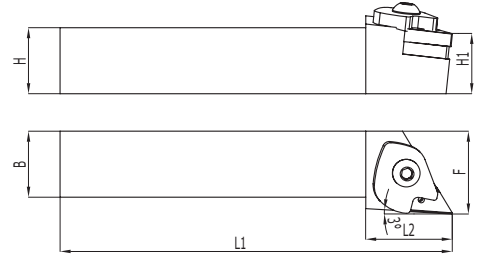

Kesici Uç Uyumluluğu Insert Suitability		Stok Stock							
ISO	R	L	H1-H	B	F	L1	L2	λS	Y0
CKJNR/L 20X20 K11	✓	✓	20	20	25	125	35	-6	-6
CKJNR/L 25X25 M11	✓	✓	25	25	32	150	40	-6	-6
CKJNR/L 20X20 K16	✓	✓	20	20	25	125	35	-6	-6
CKJNR/L 25X25 M16	✓	✓	25	25	32	150	40	-6	-6
CKJNR/L 32X32 P16	✓	✓	32	32	40	170	40	-6	-6
CKJNR/L 40X40 R16	✓	✓	40	40	50	200	45	-6	-6

Uç Insert	Altık Shim	Vida Screw	Pabuç Clamp	Vida Screw	Anahtar Allen Key
KNUX 1604..	-		C110105	M4X12	A5
	KN..016	M3X10	C160105	M6X22	

T-SİSTEM DIŞ ÇAP TORNALAMA KATERLERİ

T-SYSTEM EXTERNAL TURNING TOOLHOLDERS

MBC

TDJNR/L

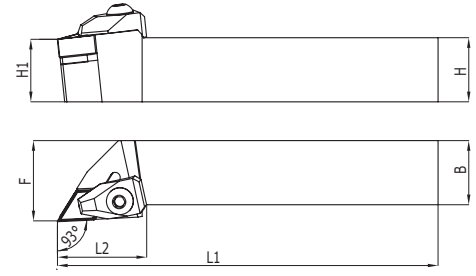

Kesici Uç Uyumluluğu Insert Suitability		Stok Stock								
ISO	R	L	H1 H	B	F	L1	L2	λS	Y0	
TDJNR/L 16X16 K11	✓	✓	16	16	21	125	30	-6	-6	
TDJNR/L 20X20 K11	✓	✓	20	20	25	125	35	-6	-6	
TDJNR/L 25X25 M11	✓	✓	25	25	32	150	40	-6	-6	
TDJNR/L 20X20 K15	✓	✓	20	20	25	125	35	-6	-6	
TDJNR/L 25X25 M15	✓	✓	25	25	32	150	40	-6	-6	
TDJNR/L 32X32 P15	✓	✓	32	32	40	170	40	-6	-6	
TDJNR/L 40X40 R15	✓	✓	40	40	50	200	45	-6	-6	

Uç Insert	Altlık Shim	Vida Screw	Pabuç Clamp	Vida Screw	Anahtar Allen Key
DNM. 1104..	DN..011	M4X11 T15	T110105	M5X23	A3
DNM. 1506..	DN..015	M4X8 A2,5	T150105	M6X27	

TDNNN

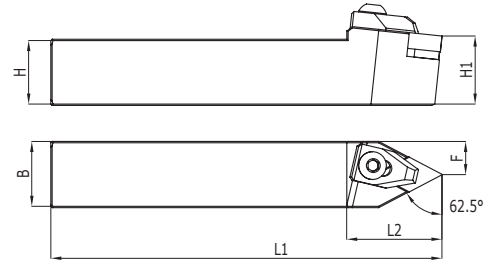

Kesici Uç Uyumluluğu Insert Suitability		Stok Stock								
ISO	R	L	H1 H	B	F	L1	L2	λS	Y0	
TDNNN 16X16 K11	✓		16	16	8	125	30	-10	0	
TDNNN 20X20 K11	✓		20	20	10	125	35	-10	0	
TDNNN 25X25 M11	✓		25	25	12.5	150	40	-10	0	
TDNNN 20X20 K15	✓		20	20	10	125	35	-10	0	
TDNNN 25X25 M15	✓		25	25	12.5	150	40	-10	0	
TDNNN 32X32 P15	✓		32	32	16	170	40	-10	0	
TDNNN 40X40 R15	✓		40	40	20	200	45	-10	0	

Uç Insert	Altlık Shim	Vida Screw	Pabuç Clamp	Vida Screw	Anahtar Allen Key
DNM. 1104..	DN..011	M4X8 T15	T110105	M5X23	A3
DNM. 1506..	DN..015	M4X8 A2,5	T150105	M6X27	

TTGNR/L

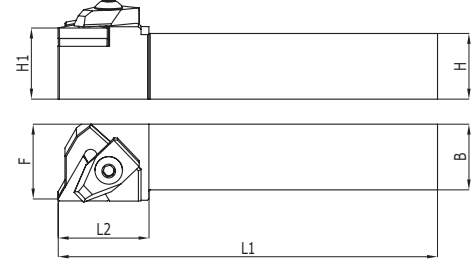

Kesici Uç Uyumluluğu Insert Suitability		Stok Stock	
ISO	R	L	

ISO	R	L	H1-H	B	F	L1	L2	λS	Y0
TTGNR/L 20X20 K16	✓	✓	20	20	25	125	35	-6	-6
TTGNR/L 25X25 M16	✓	✓	25	25	32	150	40	-6	-6
TTGNR/L 20X20 K22	✓	✓	20	20	25	125	40	-6	-6
TTGNR/L 25X25 M22	✓	✓	25	25	32	150	40	-6	-6
TTGNR/L 32X32 P22	✓	✓	32	32	40	170	40	-6	-6
TTGNR/L 40X40 R22	✓	✓	40	40	50	200	45	-6	-6

Uç Insert	Altık Shim	Vida Screw	Pabuç Clamp	Vida Screw	Anahtar Allen Key
TNMG 1604	TN..016(H)	M4X8 A2,5	T160105	M5X23	A3
TNMG 2204	TN..022(H)		T220105	M6X27	

TTJNR/L

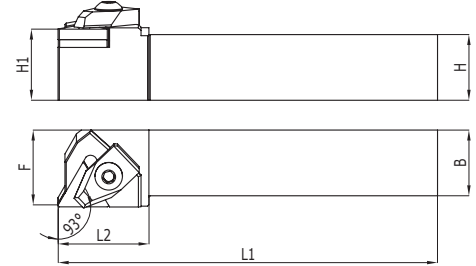

Kesici Uç Uyumluluğu Insert Suitability		Stok Stock	
ISO	R	L	

ISO	R	L	H1-H	B	F	L1	L2	λS	Y0
TTJNR/L 16X16 K16	✓	✓	16	16	21	125	35	-6	-6
TTJNR/L 20X20 K16	✓	✓	20	20	25	125	35	-6	-6
TTJNR/L 25X25 M16	✓	✓	25	25	32	150	40	-6	-6
TTJNR/L 20X20 K22	✓	✓	20	20	25	125	35	-6	-6
TTJNR/L 25X25 M22	✓	✓	25	25	32	150	40	-6	-6
TTJNR/L 32X32 P22	✓	✓	32	32	40	170	40	-6	-6
TTJNR/L 40X40 R22	✓	✓	40	40	50	200	45	-6	-6

Uç Insert	Altık Shim	Vida Screw	Pabuç Clamp	Vida Screw	Anahtar Allen Key
TNMG 1604	TN..016(H)	M4X8 A2,5	T110105	M5X23	A3
TNMG 2204	TN..022(H)		T150105	M6X27	





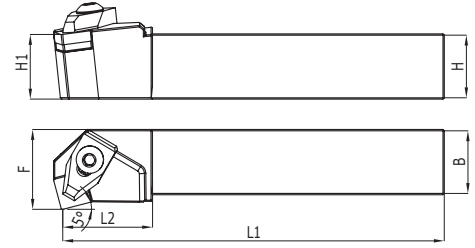

T-SİSTEM DIŞ ÇAP TORNALAMA KATERLERİ

T-SYSTEM EXTERNAL TURNING TOOLHOLDERS

MBC







TSLNR/L

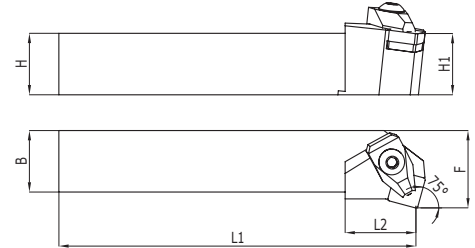

Kesici Uç Uyumluluğu Insert Suitability		Stok Stock														
ISO	R	L	H1	H	B	F	L1	L2	λ S	Y0	Uç Insert	Altılık Shim	Vida Screw	Pabuç Clamp	Vida Screw	Anahtar Allen Key
TSLNR/L 20X20 K12	✓	✓	20		20	25	125	35	-6	-6	SNMG 1204	SN..012	M4X8 A2,5	T120105	M6X27	A3
TSLNR/L 25X25 M12	✓	✓	25		25	32	150	40	-6	-6						
TSLNR/L 32X32 P15	X	X	32		32	40	170	40	-6	-6	SNMG 1506	SN..015	M5X10	T160105	M8X25	A5
TSLNR/L 40X40 R19	✓	X	40		40	50	200	45	-6	-6	SNMG 1906	SN..019		T190105		







TSKNR/L

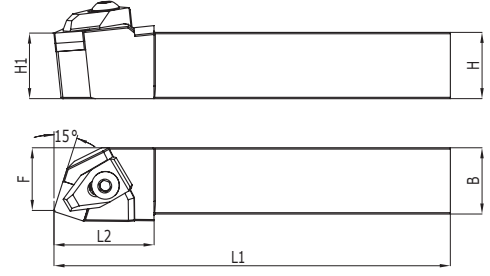

Kesici Uç Uyumluluğu Insert Suitability		Stok Stock														
ISO	R	L	H1	H	B	F	L1	L2	λ S	Y0	Uç Insert	Altılık Shim	Vida Screw	Pabuç Clamp	Vida Screw	Anahtar Allen Key
TSKNR/L 20X20 K12	X	X	20		20	25	125	35	-6	-6	SNMG 1204	SN..012	M4X8 A2,5	T120105	M6X27	A3
TSKNR/L 25X25 M12	✓	✓	25		25	32	150	40	-6	-6						
TSKNR/L 32X32 P15	X	X	32		32	40	170	40	-6	-6	SNMG 1506	SN..015	M5X10	T160105	M8X25	A5
TSKNR/L 40X40 R19	X	X	40		40	50	200	45	-6	-6	SNMG 1906	SN..019		T190105		







TSRNR/L

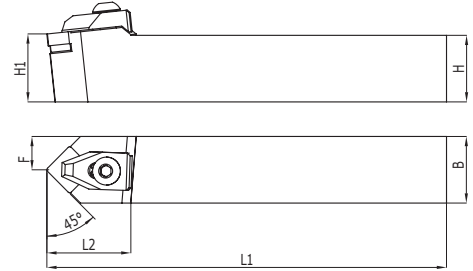

Kesici Uç Uyumluluğu Insert Suitability		Stok Stock													
ISO	R	L	H1-H	B	F	L1	L2	λS	γ_0	Uç Insert	Altık Shim	Vida Screw	Pabuç Clamp	Vida Screw	Anahtar Allen Key
TSRNR/L 20X20 K12	✓	✓	20	20	19	125	35	-6	-6	SNMG 1204	SN..012	M4X8 A2,5	T120105	M6X27	A3
TSRNR/L 25X25 M12	✓	✓	25	25	24	150	40	-6	-6						
TSRNR/L 32X32 P15	X	X	32	32	30	170	40	-6	-6	SNMG 1506	SN..015	M5X10	T160105		
TSRNR/L 40X40 R19	X	X	40	40	38	200	45	-6	-6	SNMG 1906			SN..019	T190105	

TSDNN



Kesici Uç Uyumluluğu Insert Suitability		Stok Stock													
ISO	R	L	H1-H	B	F	L1	L2	λS	γ_0	Uç Insert	Altık Shim	Vida Screw	Pabuç Clamp	Vida Screw	Anahtar Allen Key
TSDNN 20X20 K12	✓		20	20	10	125	35	-6	0	SNMG 1204	SN..012	M4X8 A2,5	T120105	M6X27	A3
TSDNN 25X25 M12	✓		25	25	12.5	150	40	-6	0						
TSDNN 32X32 P12	✓		32	32	16	170	40	-6	0						
TSDNN 32X32 P19	✓		32	32	16	170	40	-6	-6	SNMG 1906	SN..019	M5X10	T190105	M8X25	A5
TSDNN 40X40 R19	✓		40	40	20	200	45	-6	-6						





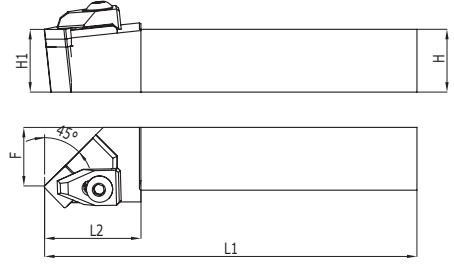

T-SİSTEM DIŞ ÇAP TORNALAMA KATERLERİ

T-SYSTEM EXTERNAL TURNING TOOLHOLDERS

MBC







TSSNR/L

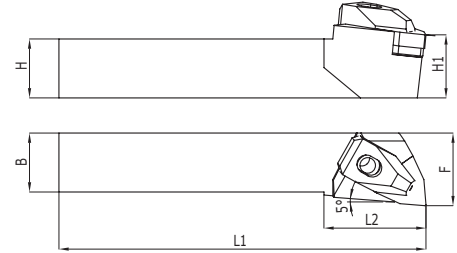

Kesici Uç Uyumluluğu Insert Suitability		Stok Stock													
ISO	R	L	H1-H	B	F	L1	L2	λS	Y0	Uç Insert	Altık Shim	Vida Screw	Pabuç Clamp	Vida Screw	Anahtar Allen Key
TSSNR/L 20X20 K12	✓	✓	20	20	19	125	35	-6	-6	SNMG 1204	SN..012	M4X8 A2,5	T120105	M6X27	A3
TSSNR/L 25X25 M12	✓	✓	25	25	24	150	40	-6	-6						
TSSNR/L 32X32 P12	✓	✓	32	32	30	170	40	-6	-6						
TSSNR/L 32X32 P15	✓	✓	32	32	30	170	40	-6	-6	SNMG 1506	SN..015	M5X10	T160105	M8X25	A5
TSSNR/L 32X32 P19	✓	✓	32	32	30	170	40	-6	-6	SNMG 1906	SN..019		T190105		
TSSNR/L 40X40 R19	✓	✓	40	40	38	200	45	-6	-6						

TWLNRL



Kesici Uç Uyumluluğu Insert Suitability		Stok Stock													
ISO	R	L	H1-H	B	F	L1	L2	λS	Y0	Uç Insert	Altık Shim	Vida Screw	Pabuç Clamp	Vida Screw	Anahtar Allen Key
TWLNRL/L 16X16 K06	✓	✓	16	16	21	125	30	-6	-6	WNN.0602..			T060105	M5X15	A3
TWLNRL/L 20X20 K06	✓	✓	20	20	25	125	35	-6	-6						
TWLNRL/L 25X25 M06	✓	✓	25	25	32	150	40	-6	-6						
TWLNRL/L 20X20 K08	✓	✓	20	20	25	125	35	-6	-6	WNN.0804..	WN..008(H)	M4X8 A2.5	T080105	M6X27	
TWLNRL/L 25X25 M08	✓	✓	25	25	32	150	40	-6	-6						
TWLNRL/L 32X32 P08	✓	✓	32	32	40	170	40	-6	-6						
TWLNRL/L 40X40 R08	✓	✓	40	40	50	200	45	-6	-6						

TVJNR/L

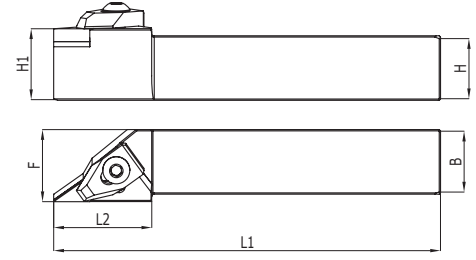

Kesici Uç Uyumluluğu Insert Suitability		Stok Stock							
ISO	R	L	H1-H	B	F	L1	L2	λS	Y0
TVJNR/L 20X20 K16	✓	✓	20	20	25	125	35	-6	-6
TVJNR/L 25X25 M16	✓	✓	25	25	32	150	40	-6	-6
TVJNR/L 32X32 P16	✓	✓	32	32	40	170	40	-6	-6
TVJNR/L 40X40 R16	✓	✓	40	40	50	200	45	-6	-6

Uç Insert	Altık Shim	Vida Screw	Pabuç Clamp	Vida Screw	Anahtar Allen Key
VNMG 1604	VN..016	M4X11 T15	T160105	M6X27	A3

TVNNN

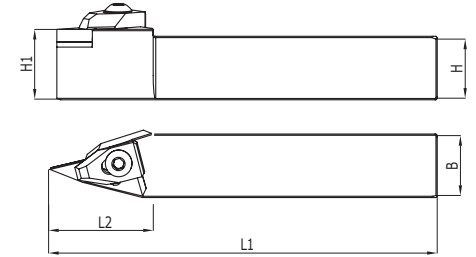

Kesici Uç Uyumluluğu Insert Suitability		Stok Stock							
ISO	R	L	H1-H	B	F	L1	L2	λS	Y0
TVNNN 20X20 K16	✓		20	20	10	125	30	-10	0
TVNNN 25X25 M16	✓		25	25	12.5	150	35	-10	0
TVNNN 32X32 P16	✓		32	32	16	170	40	-10	0

Uç Insert	Altık Shim	Vida Screw	Pabuç Clamp	Vida Screw	Anahtar Allen Key
VNMG 1604	VN..016	M4X11 T15	T160105	M6X27	A3





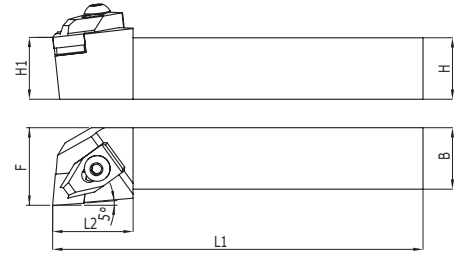

T-SİSTEM DIŞ ÇAP TORNALAMA KATERLERİ

T-SYSTEM EXTERNAL TURNING TOOLHOLDERS

MBC







TCLNR/L

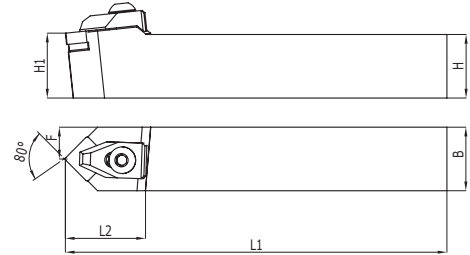

Kesici Uç Uyumluluğu Insert Suitability		Stok Stock															
ISO	R	L	H1 H	B	F	L1	L2	λS	Y0	Uç Insert	Altılık Shim	Vida Screw	Pabuç Clamp	Vida Screw	Anahtar Allen Key		
TCLNR/L 20X20 K12	✓	✓	20	20	25	125	35	-6	-6	CNM. 1204..	CN..012	M4X8 A2,5	T120105	M6X27	A3		
TCLNR/L 25X25 M12	✓	✓	25	25	32	150	40	-6	-6	CNM. 1606..	CN..016	M5X10	T160105				
TCLNR/L 25X25 M16	✓	✓	25	25	32	150	40	-6	-6	CNM. 1204..	CN..012	M4X8 A2,5	T120105				
TCLNR/L 32X32 P12	✓	✓	32	32	40	170	40	-6	-6	CNM. 1606..	CN..016	M5X10	T160105				
TCLNR/L 32X32 P16	✓	✓	32	32	40	170	40	-6	-6	CNM. 1906..	CN..019		T190105			M8X25	A5
TCLNR/L 32X32 P19	✓	✓	32	32	40	170	40	-6	-6	CNM. 1606..	CN..016		T160105			M6X25	A3
TCLNR/L 40X40 R16	✓	✗	40	40	50	200	45	-6	-6	CNM. 1906..	CN..019		T190105			M8X25	A5
TCLNR/L 40X40 R19	✓	✓	40	40	50	200	45	-6	-6	CNM. 1906..	CN..019	T190105	M8X25			A5	

TCZNN



Kesici Uç Uyumluluğu Insert Suitability		Stok Stock													
ISO	R	L	H1 H	B	F	L1	L2	λS	Y0	Uç Insert	Altılık Shim	Vida Screw	Pabuç Clamp	Vida Screw	Anahtar Allen Key
TCZNN 20X20 K12	✓		20	20	10	125	35	-10	0	CNM. 1204..	CN..012	M4X8 A2,5	T120105	M6X27	A3
TCZNN 25X25 M12	✓		25	25	12.5	150	40	-10	0						
TCZNN 32X32 P12	✓		32	32	16	170	40	-10	0						

TCMNN

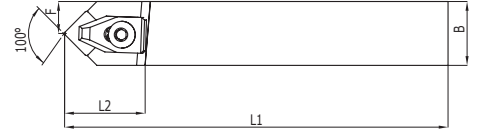

Kesici Uç Uyumluluğu Insert Suitability	Stok Stock													
		H1 H	B	F	L1	L2	λS	Υ0	Uç Insert	Altık Shim	Vida Screw	Pabuç Clamp	Vida Screw	Anahtar Allen Key
TCMNN 20X20 K12	✓	20	20	10	125	35	-10	0	CNM. 1204..	CN..012	M4X8 A2,5	T120105	M6X27	A3
TCMNN 25X25 M12	✓	25	25	12.5	150	40	-10	0						
TCMNN 32X32 P12	✓	32	32	16	170	40	-10	0						



M-SİSTEM DIŞ ÇAP TORNALAMA KATERLERİ - M-SYSTEM EXTERNAL TURNING TOOLHOLDERS



MTJNR/L

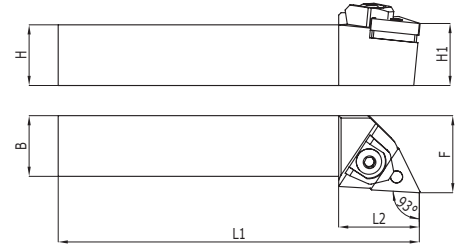

Kesici Uç Uyumluluğu Insert Suitability		Stok Stock													
ISO	R	L	H1 H	B	F	L1	L2	λS	Y0	Uç Insert	Altılık Shim	Altılık Pimi Lock Pin	Pabuç Clamp	Vida Screw	Anahtar Allen Key
MTJNR/L 16X16 K16	✓	✓	16	16	20	125	35	-6	-6	TNM.1604	TN..016 (P)	5X3.6X15	M160105	M5X23	A3
MTJNR/L 20X20 K16	✓	✓	20	20	25	125	35	-6	-6						
MTJNR/L 25X25 M16	✓	✓	25	25	32	150	40	-6	-6						
MTJNR/L 32X32 P16	✓	✓	32	32	40	170	40	-6	-6	TNM.2204	TN..022 (P)	6X5X18	M220105	M6X27	
MTJNR/L 25X25 M22	✓	✓	25	25	32	150	40	-6	-6						
MTJNR/L 32X32 P22	✓	✓	32	32	40	170	40	-6	-6						
MTJNR/L 40X40 R22	✓	✓	40	40	50	200	45	-6	-6						

MTENN

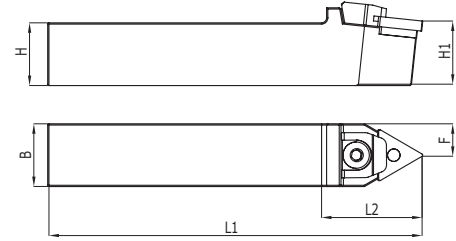

Kesici Uç Uyumluluğu Insert Suitability		Stok Stock													
ISO	R	L	H1 H	B	F	L1	L2	λS	Y0	Uç Insert	Altılık Shim	Altılık Pimi Lock Pin	Pabuç Clamp	Vida Screw	Anahtar Allen Key
MTENN 16X16 K16	✓		16	16	8	125	35	-10	0	TNM.1604	TN..016 (P)	5X3.6X15	M160105	M5X23	A3
MTENN 20X20 K16	✓		20	20	10	125	35	-10	0						
MTENN 25X25 M16	✓		25	25	12.5	150	40	-10	0						
MTENN 32X32 P16	✓		32	32	16	170	40	-10	0	TNM.2204	TN..022 (P)	6X5X18	M220105	M6X27	
MTENN 25X25 M22	✓		25	25	12.5	150	40	-10	0						
MTENN 32X32 P22	✓		32	32	16	170	40	-10	0						
MTENN 40X40 R22	✓		40	40	20	200	45	-10	0						

M-SİSTEM DIŞ ÇAP TORNALAMA KATERLERİ

M-SYSTEM EXTERNAL TURNING TOOLHOLDERS

MBC

MWLNRL

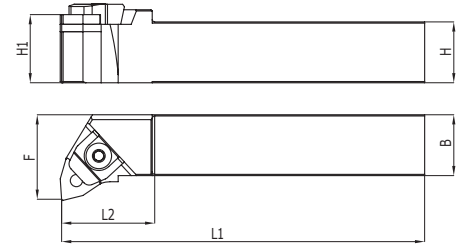

Kesici Uç Uyumluluğu Insert Suitability		Stok Stock								
ISO	R	L	H1 H	B	F	L1	L2	λS	Y0	
MWLNRL 16X16 K06	✓	✓	16	16	20	125	35	-6	-6	
MWLNRL 20X20 K06	✓	✓	20	20	25	125	35	-6	-6	
MWLNRL 25X25 M06	✓	✓	25	25	32	150	40	-6	-6	
MWLNRL 20X20 K08	✓	✓	20	20	25	125	35	-6	-6	
MWLNRL 25X25 M08	✓	✓	25	25	32	150	40	-6	-6	
MWLNRL 32X32 P08	✓	✓	32	32	40	170	40	-6	-6	
MWLNRL 40X40 R08	✓	✓	40	40	50	200	45	-6	-6	

Uç Insert	Altık Shim	Altık Pimi Lock Pin	Pabuç Clamp	Vida Screw	Anahtar Allen Key
WNM.0604		5X3.6X15	M060105	M5X23	A3
WNM.0804	WN.008(P)	6X5X18	M080105	M6X27	

MWDNN

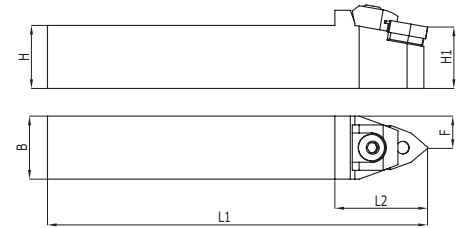

Kesici Uç Uyumluluğu Insert Suitability		Stok Stock								
ISO	R	L	H1 H	B	F	L1	L2	λS	Y0	
MWDNN 16X16 K06	X		16	16	8	125	35	-10	0	
MWDNN 20X20 K06	X		20	20	10	125	35	-10	0	
MWDNN 25X25 M06	X		25	25	12.5	150	40	-10	0	
MWDNN 20X20 K08	✓		20	20	10	125	40	-10	0	
MWDNN 25X25 M08	✓		25	25	12.5	150	40	-10	0	
MWDNN 32X32 P08	X		32	32	16	170	40	-10	0	
MWDNN 40X40 R08	X		40	40	20	200	45	-10	0	

Uç Insert	Altık Shim	Altık Pimi Lock Pin	Pabuç Clamp	Vida Screw	Anahtar Allen Key
WNM.0604		5X3.6X15	M060105	M5X23	A3
WNM.0804	WN..08(P)	6X5X18	M080105	M6X27	



Siz üretirken biz destek oluyoruz / We support while you produce

MBC www.baydarlar.com

S-SİSTEM İÇ ÇAP TORNALAMA KATERLERİ - S-SYSTEM INTERNAL TURNING TOOLHOLDERS



SVUBR

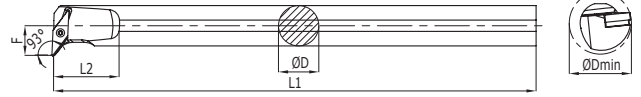

Kesici Uç Uyumluluğu Insert Suitability	Stok Stock		D	D min	F	L1	L2	λF	YP
	R	L							
ISO	R	L	D	D min	F	L1	L2	λF	YP
S16Q SVUBR/L 11	✓	✓	16	20	11	180	40	-8	0
S20R SVUBR/L 11	✓	✓	20	25	13	200	40	-8	0
S25S SVUBR/L 16	✓	✓	25	32	17	250	50	-9	0
S32T SVUBR/L 16	✓	✓	32	40	22	300	60	-9	0
S40V SVUBR/L 16	✓	✓	40	50	27	400	70	-9	0

Uç Insert	Altılık Shim	Vida Screw	Vida Screw	Anahtar Torx Key
VBM. 1103..	—	—	M2.5X7	T08
VBM. 1604..	VB..016	M5X0.5XM3.5	M3.5X11	T15

SVUCR

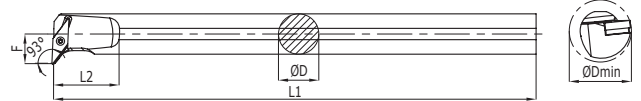

Kesici Uç Uyumluluğu Insert Suitability	Stok Stock		D	D min	F	L1	L2	λF	YP
	R	L							
ISO	R	L	D	D min	F	L1	L2	λF	YP
S16Q SVUCR/L11	✓	✓	16	20	11	180	40	-8	0
S20R SVUCR/L 11	✓	✓	20	25	13	200	40	-8	0
S25S SVUCR/L 16	✓	✓	25	32	17	250	50	-9	0
S32T SVUCR/L 16	✓	✓	32	40	22	300	60	-9	0
S40V SVUCR/L 16	✓	✓	40	50	27	400	70	-9	0

Uç Insert	Altılık Shim	Vida Screw	Vida Screw	Anahtar Torx Key
VCM. 1103..	—	—	M2.5X7	T08
VCM. 1604..	VC..016	M5X0.5XM3.5	M3.5X11	T15

SDUCR

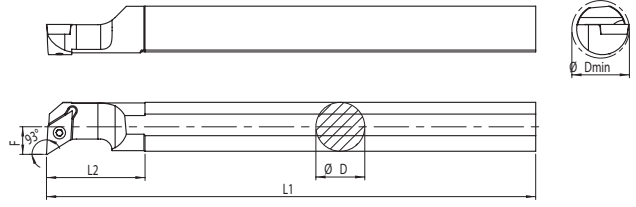

Kesici Uç Uyumluluğu Insert Suitability	Stok Stock		D	D min	F	L1	L2	λF	YP	Uç Insert	Altık Shim	Vida Screw	Vida Screw	Anahtar Torx Key
	R	L												
S10K SDUCR/L 07	✓	✓	10	13	7.5	125	25	-11	0	DC.T 0702..	—	—	M2,5X5	T08
S12M SDUCR/L 07	✓	✓	12	16	9	150	30	-9	0		—	—	M2,5X7	
S16Q SDUCR/L 07	✓	✓	16	20	11	180	35	-9	0		—	—	M2,5X7	
S16Q SDUCR/L 11	✓	✓	16	20	11	180	35	-9	0	DC.T 11T3..	—	—	M3,5X8	T15
S20R SDUCR/L 07	✓	✓	20	25	13	200	40	-8	0	DC.T 0702..	—	—	M2,5X7	T08
S20R SDUCR/L 11	✓	✓	20	25	13	200	40	-8	0	DC.T 11T3..	—	—	M3,5X8	T15
S25S SDUCR/L 07	✓	✓	25	32	17.5	250	50	-8	0	DC.T 0702..	—	—	M2,5X7	T08
S25S SDUCR/L 11	✓	✓	25	32	17.5	250	50	-8	0	DC.T 11T3..	DC..011	M5X0.5XM3.5	M3,5X11	T15
S32T SDUCR/L 11	✓	✓	32	40	23	300	60	-8	0					
S40V SDUCR/L 11	✓	✓	40	50	27	400	60	-8	0					

SDQCR

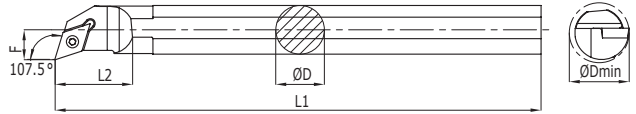

Kesici Uç Uyumluluğu Insert Suitability	Stok Stock		D	D min	F	L1	L2	λF	YP	Uç Insert	Altık Shim	Vida Screw	Vida Screw	Anahtar Torx Key
	R	L												
S10K SDQCR/L 07	✓	✓	10	13	7.5	125	25	-11	0	DC.T 0702..	—	—	M2,5X5	T08
S12M SDQCR/L 07	✓	✓	12	16	9	150	30	-9	0		—	—	M2,5X7	
S16Q SDQCR/L 07	✓	✓	16	20	11	180	35	-9	0		—	—	M2,5X7	
S16Q SDQCR/L 11	✓	✓	16	20	11	180	35	-9	0	DC.T 11T3..	—	—	M3,5X8	T15
S20R SDQCR/L 07	✓	✓	20	25	13	200	40	-8	0	DC.T 0702..	—	—	M2,5X7	T08
S20R SDQCR/L 11	✓	✓	20	25	13	200	40	-8	0	DC.T 11T3..	—	—	M3,5X8	T15
S25S SDQCR/L 07	✓	✓	25	32	17.5	250	50	-8	0	DC.T 0702..	—	—	M2,5X7	T08
S25S SDQCR/L 11	✓	✓	25	32	17.5	250	50	-8	0	DC.T 11T3..	DC..011	M5X0.5XM3.5	M3,5X11	T15
S32T SDQCR/L 11	✓	✓	32	40	23	300	60	-8	0					

SD-CR

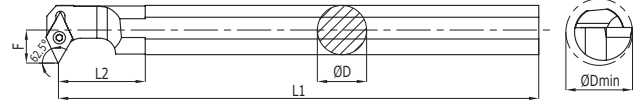

Kesici Uç Uyumluluğu Insert Suitability	Stok Stock									
	ISO	R	L	D	D min	F	L1	L2	λF	YP
S10K SD-CR/L 07	✓	✓	10	14	8.5	125	28	-9	0	
S12M SD-CR/L 07	✓	✓	12	16	9	150	30	-9	0	
S16Q SD-CR/L 07	✓	✓	16	23	14	180	40	-8	0	
S16Q SD-CR/L 11	✓	✓	16	23	14	180	40	-8	0	
S20R SD-CR/L 11	✓	✓	20	25	14.5	200	45	-8	0	
S25S SD-CR/L 11	✓	✓	25	32	19	250	55	-8	0	
S32T SD-CR/L 11	✓	✓	32	40	23	300	60	-12	0	
S40V SD-CR/L 11	✓	X	32	50	27	400	70	-10	0	

Uç Insert	Altılık Shim	Vida Screw	Vida Screw	Anahtar Torx Key
DC.T 0702..	—	—	M2.5X7	T08
DC.T 11T3..	—	—	M3.5X8	T15
	DC..011	M5X0.5XM3.5	M3.5X11	

SDXCR

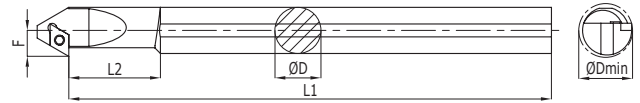



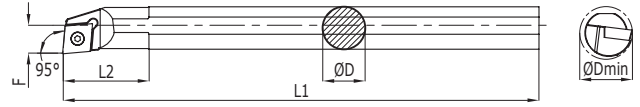

Kesici Uç Uyumluluğu Insert Suitability	Stok Stock									
	ISO	R	L	D	D min	F	L1	L2	λF	YP
S12M SDXCR/L 07	✓	✓	12	16	9	150	30	-7	0	
S16Q SDXCR/L 07	✓	✓	16	22	12.5	180	40	-9	0	
S16Q SDXCR/L 11	✓	✓	16	22	12.5	180	40	-9	0	
S20R SDXCR/L 11	✓	✓	20	25	14	200	55	-9	0	
S25S SDXCR/L 11	✓	✓	25	32	17.5	250	65	-10	0	
S32T SDXCR/L 11	✓	✓	32	40	23	300	80	-13	0	
S40V SDXCR/L 11	✓	✓	40	50	27	400	80	-13	0	

Uç Insert	Altılık Shim	Vida Screw	Vida Screw	Anahtar Torx Key
DC.T 0702..	—	—	M2.5X5	T08
DC.T 11T3..	—	—	M2.5X7	T08
	—	—	M3.5X8	T15
	DC..011	M5X0.5XM3.5	M3.5X11	





SCLCR

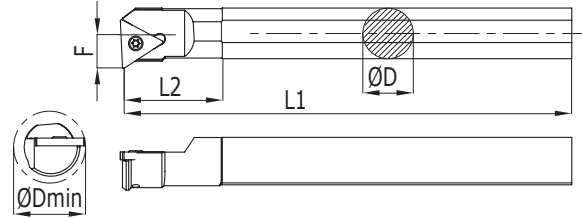

Kesici Uç Uyumluluğu Insert Suitability	Stok Stock													
	ISO	R	L	D	D min	F	L1	L2	λF	YP	Uç Insert	Altılık Shim	Vida Screw	Vida Screw
S06-08H SCLCR/L 06	✓	✓	8	10	6	100	30	-10	0	CC.T 0602..	—	—	M2,5X5	T08
S08H SCLCR/L 06	✓	✓	8	11	6	100	25	-10	0		—	—		
S10K SCLCR/L 06	✓	✓	10	13	7	125	25	-10	0		—	—		
S12M SCLCR/L 06	✓	✓	12	16	9	150	30	-8	0		—	—		
S12M SCLCR/L 09	✓	✓	12	16	9	150	30	-8	0	CC.T 09T3..	—	—	M3,5X6	T15
S16Q SCLCR/L 06	✓	✓	16	20	11	180	35	-8	0	CC.T 0602..	—	—	M2,5X7	T08
S16Q SCLCR/L 09	✓	✓	16	20	11	180	35	-8	0	CC.T 09T3..	—	—	M3,5X8	T15
S20R SCLCR/L 09	✓	✓	20	25	13	200	40	-8	0		—	—	M3,5X11	
S25S SCLCR/L 09	✓	✓	25	32	17	250	50	-8	0		—	—		
S25S SCLCR/L 12	✓	✓	25	32	17	250	50	-8	0	CC.T 1204..	CC..12	M6XM4	M4X14	T20
S32T SCLCR/L 09	✓	✓	32	40	23	300	60	-8	0	CC.T 09T3..	—	—	M3,5X11	T15
S32T SCLCR/L 12	✓	✓	32	40	23	300	60	-8	0	CC.T 1204..	CC..12	M6XM4	M4X14	T20
S40V SCLCR/L 12	✓	✗	40	50	27	400	70	-8	0					

STFCR



Kesici Uç Uyumluluğu Insert Suitability	Stok Stock													
	ISO	R	L	D	D min	F	L1	L2	λF	YP	Uç Insert	Altılık Shim	Vida Screw	Vida Screw
S16Q STFCR/L 16	✓	✓	16	20	11	180	35	-9	0	TC.T 16T3..	—	—	M3,5X8	T15
S20R STFCR/L 16	✓	✓	20	25	13	200	40	-8	0		TC..016	M5X0,5XM3,5	M3,5X11	
S25S STFCR/L 16	✓	✓	25	32	17,5	250	50	-8	0					
S32T STFCR/L 16	✓	✓	32	40	23	300	60	-8	0					



Siz üretirken biz destek oluyoruz / We support while you produce

MBC www.baydarlar.com

C-SİSTEM & T-SİSTEM İÇ ÇAP TORNALAMA KATERLERİ - C-SYSTEM & T-SYSTEM INTERNAL TURNING TOOLHOLDERS



CKUNR

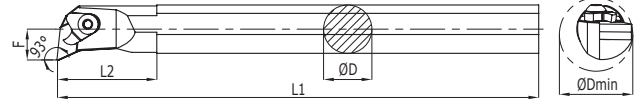

Kesici Uç Uyumluluğu Insert Suitability		Stok Stock		D	D min	F	L1	L2	λF	YP
ISO	R	L								
S25S CKUNR/L 16	✓	✓		25	32	17	250	50	-12	-5
S25S CKUNR/L 16	✓	✓		25	32	17	250	50	-12	-5
S32T CKUNR/L 16	✓	✓		32	40	22	300	60	-12	-5
S40V CKUNR/L 16	✓	✓		40	50	27	400	65	-9	-5
S50W CKUNR/L 16	✓	X		50	63	35	450	70	-7	-5
S60W CKUNR/L 16	✓	X		60	75	35	450	70	-7	-5

Uç Insert	Altık Shim	Vida Screw	Pabuç Clamp	Vida Screw	Anahtar Allen Key
KNUX 1604..	KN..016 (R/L)	M3X8 A2.5	C160105	M6X27	A5

CTUPR

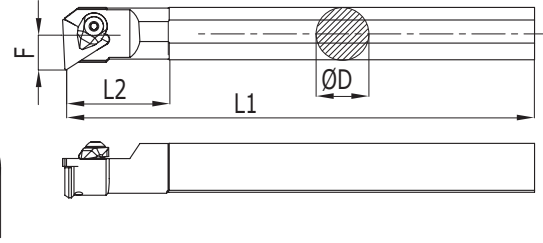





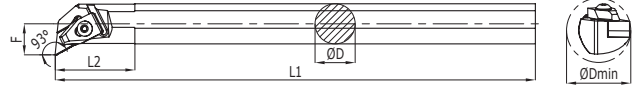

Kesici Uç Uyumluluğu Insert Suitability		Stok Stock		D	D min	F	L1	L2	λF	YP
ISO	R	L								
S16Q CTUPR/L 16	✓	X		16	21	9	180	35	-8	-
S20R CTUPR/L 16	✓	X		20	25	13	200	40	-8	-
S25S CTUPR/L 16	✓	X		25	32	17	250	50	-8	-

Uç Insert	Altık Shim	Vida Screw	Pabuç Clamp	Vida Screw	Anahtar Allen Key
TPKN 1603	TP..16	M4x10	C160105	M5X12	A4







TDUNR

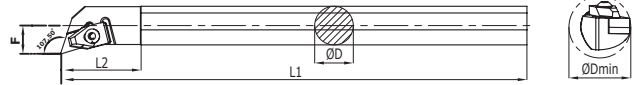

Kesici Uç Uyumluluğu Insert Suitability		Stok Stock																	
ISO	R	L	D	D min	F	L1	L2	λF	YP	Uç Insert	Altılık Shim	Vida Screw	Pabuç Clamp	Vida Screw	Anahtar Allen Key				
S20R TDUNR/L 11	✓	✓	20	25	13	200	40	-11	-5	DNM. 1104..			T110105	M5X15	A3				
S25S TDUNR/L 15	✓	✓	25	32	17	250	50	-13	-5					M6X20					
S32T TDUNR/L 15	✓	✓	32	40	22	300	60	-12	-5					DNM. 1506..		DN..015	M4X8 A2.5	T150105	M6X27
S40V TDUNR/L 15	✓	✓	40	50	27	400	70	-12	-5										
S50W TDUNR/L 15	✓	✓	50	63	35	450	75	-12	-5										
S60W TDUNR/L 15	✓	✗	60	75	40	450	75	-12	-5										

TDQNR



Kesici Uç Uyumluluğu Insert Suitability		Stok Stock													
ISO	R	L	D	D min	F	L1	L2	λF	YP	Uç Insert	Altılık Shim	Vida Screw	Pabuç Clamp	Vida Screw	Anahtar Allen Key
S25S TDQNR/L 15	✓	✗	25	32	17	250	50	-13	-5	DNM. 1506..	DN..015	M4X8 A2.5	T150105	M6X20	A3
S32T TDQNR/L 15	✓	✗	32	40	22	300	60	-12	-5						
S40V TDQNR/L 15	✓	✗	40	50	27	400	70	-12	-5						
S50W TDQNR/L 15	✓	✗	50	63	35	450	75	-12	-5						

TD-NR

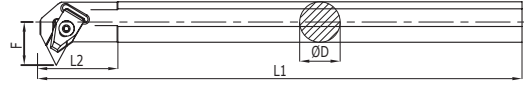

Kesici Uç Uyumluluğu Insert Suitability		Stok Stock								
ISO	R	L	D	D min	F	L1	L2	λF	YP	
S32T TD-NR/L 15	✓	X	32	43	26.5	300	60	-15	0	
S40V TD-NR/L 15	✓	X	40	50	29.5	400	70	-13	0	
S50W TD-NR/L 15	✓	X	50	62	35	450	70	-13	0	

Uç Insert	Altlık Shim	Vida Screw	Pabuç Clamp	Vida Screw	Anahtar Allen Key
DNM. 1506..	DN..015	M4X8 A2.5	T150105	M6X27	A3

TCLNR

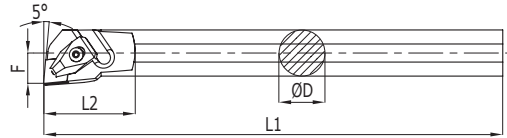
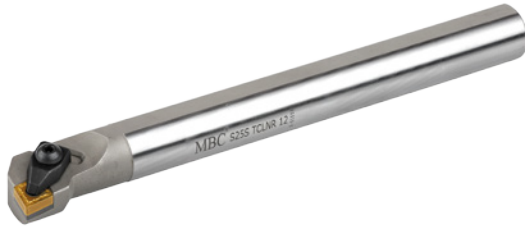





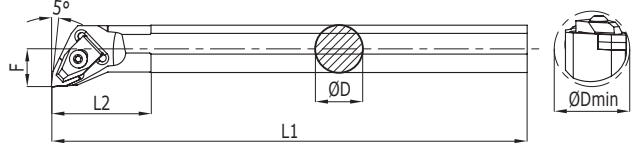
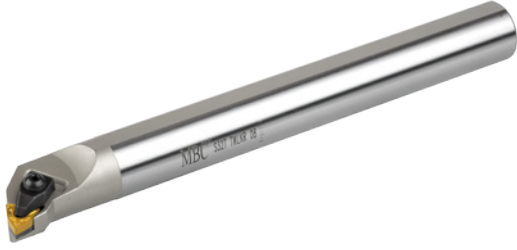

Kesici Uç Uyumluluğu Insert Suitability		Stok Stock								
ISO	R	L	D	D min	F	L1	L2	λF	YP	
S25S TCLNR/L 12	✓	✓	25	32	17	250	50	-12	-5	
S32T TCLNR/L 12	✓	✓	32	40	22	300	60	-12	-5	
S32T TCLNR/L 16	✓	✓	32	40	22	300	60	-12	-5	
S40V TCLNR/L 12	✓	X	40	40	27	400	70	-12	-5	
S40V TCLNR/L 16	✓	X	40	50	27	400	70	-12	-5	
S50W TCLNR/L 16	✓	X	50	63	35	450	75	-12	-5	
S60W TCLNR/L 16	✓	X	60	75	40	450	75	-12	-5	

Uç Insert	Altlık Shim	Vida Screw	Pabuç Clamp	Vida Screw	Anahtar Allen Key
CNM. 1204..	CN..012	M4X8 A2,5	T120105	M6X20	A3
CNM. 1606..	CN..016	M5X8 A3	T160105	M6X27	
CNM. 1204..	CN..012	M4X8 A2,5	T120105		
CNM. 1606..	CN..016	M5X8 A3	T160105		

TWLNR



Kesici Uç Uyumluluğu Insert Suitability	Stok Stock														
	ISO	R	L	D	D min	F	L1	L2	λF	YP	Uç Insert	Altılık Shim	Vida Screw	Pabuç Clamp	Vida Screw
S20R TWLNR/L 06	✓	×	20	25	13	200	40	-11	-5	WNM. 0602..			T060105	M5X15	A3
S25S TWLNR/L 08	✓	✓	25	32	17	250	50	-13	-5	WNM. 0804..	WN.008(H)	M4X8 A2.5	T080105	M6X20	
S32T TWLNR/L 08	✓	✓	32	40	22	300	60	-12	-5						
S40V TWLNR/L 08	✓	×	40	50	27	400	70	-12	-5						
S50W TWLNR/L 08	✓	×	50	63	35	450	75	-12	-5						
S60W TWLNR/L 08	✓	×	60	75	40	450	75	-12	-5						





Siz üretirken biz destek oluyoruz / We support while you produce

MBC www.baydarlar.com

M-SİSTEM İÇ ÇAP TORNALAMA KATERLERİ - M-SYSTEM INTERNAL TURNING TOOLHOLDERS



MTUNR

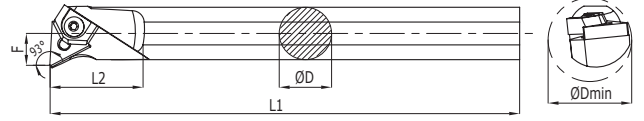

Kesici Uç Uyumluluğu Insert Suitability		Stok Stock							
ISO	R	L	D	D min	F	L1	L2	λF	YP
S20R MTUNR/L 16	✓	✓	20	25	13	200	40	-13	-5
S25S MTUNR/L 16	✓	✓	25	32	17	250	50	-12	-5
S32T MTUNR/L 16	✓	✓	32	40	22	300	60	-12	-5
S40V MTUNR/L 16	✓	x	40	50	27	400	70	-12	-5
S32T MTUNR/L 22	✓	✓	32	40	22	300	60	-12	-5
S40V MTUNR/L 22	✓	x	40	50	27	400	70	-12	-5
S50W MTUNR/L 22	✓	x	50	63	35	450	75	-12	-5
S60W MTUNR/L 22	✓	x	60	75	40	450	75	-12	-5

Uç Insert	Altık Shim	Altık Pimi Lock Pin	Pabuç Clamp	Vida Screw	Anahtar Allen Key
TNM. 1604..	-	-	M160105	M5X15	A3
	TN..016(P)	5X3.6X12.5		M5X23	
TNM. 2204..	TN..022(P)	6X5X15	M220105	M6X27	

MT-NR

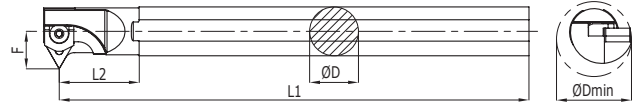

Kesici Uç Uyumluluğu Insert Suitability		Stok Stock							
ISO	R	L	D	D min	F	L1	L2	λF	YP
S20R MT-NR/L 16	✓	x	20	27	16	200	40	-15	0
S25S MT-NR/L 16	✓	✓	25	33	19.5	250	50	-14	0
S32T MT-NR/L 16	✓	✓	32	40	23	300	55	-13	0
S40V MT-NR/L 16	✓	x	40	50	29.5	400	70	-15	0
S50W MT-NR/L 16	✓	x	50	62	35	450	70	-15	0

Uç Insert	Altık Shim	Altık Pimi Lock Pin	Pabuç Clamp	Vida Screw	Anahtar Allen Key
TNM. 1604..	-	5X3.6X15	M160105	M5X15	A3
	TN..016(P)				

MTQNR

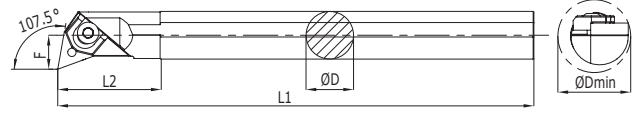

Kesici Uç Uyumluluğu Insert Suitability	Stok Stock														
ISO	R	L	D	D min	F	L1	L2	λF	YP						
S20R MTQN R/L 16	✓	X	20	25	13	200	40	-13	-5						
S25S MTQN R/L 16	✓	X	25	32	17	250	50	-12	-5						
S32T MTQN R/L 16	✓	X	32	40	22	300	60	-11	-5						
S40V MTQN R/L 16	✓	X	40	50	27	400	70	-11	-5						
S32T MTQN R/L 22	✓	X	32	40	22	300	60	-11	-5						
S40V MTQN R/L 22	✓	X	40	50	27	400	70	-11	-5						

Uç Insert	Altılık Shim	Altılık Pimi Lock Pin	Pabuç Clamp	Vida Screw	Anahtar Allen Key
TNM. 1604..	-	5X3.6X15	M160105	M5X15	A3
TNM. 2204..	TN..016(P)	6X5X18	M220105	M5X23	
	TN..022(P)	6X5X18	M220105	M6X27	

MWLN R

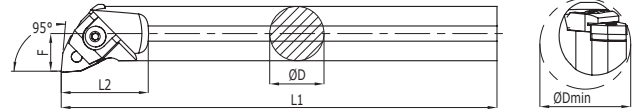

Kesici Uç Uyumluluğu Insert Suitability	Stok Stock														
ISO	R	L	D	D min	F	L1	L2	λF	YP						
S16Q MWLN R/L 06	✓	X	16	20	11	180	-5	-13	-5						
S20R MWLN R/L 06	✓	X	20	25	13	200	-5	-13	-5						
S25S MWLN R/L 08	✓	✓	25	32	17	250	-5	-13	-5						
S32T MWLN R/L 08	✓	✓	32	40	22	300	-5	-12	-5						
S40V MWLN R/L 08	✓	✓	40	50	27	400	-5	-14	-5						
S50W MWLN R/L 08	✓	X	50	63	35	450	-5	-12	-5						
S60W MWLN R/L 08	✓	X	60	75	40	450	-5	-12	-5						

Uç Insert	Altılık Shim	Altılık Pimi Lock Pin	Pabuç Clamp	Vida Screw	Anahtar Allen Key
WNM. 0604..		5x3,6x15	M060105	M5X15	A3
WNM. 0804..	WN..008	6x5x15	M080105	M6X20	
				M6X27	



Siz üretirken biz destek oluyoruz / We support while you produce

MBC www.baydarlar.com

ŞAFTLI TARAMALAR - MILLING TOOLS



APKT

AP..1003

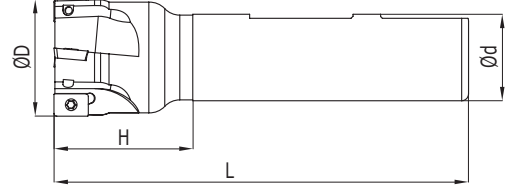

Kesici Uç Uyumluluğu Insert Suitability	Stok Stock	Inter Cooland	D	Z	H	L	d	Uç Insert	Vida Screw	Anahtar Torx Key
ISO AP..1003										
EM90 D16 W16 L100 Z02 AP..1003..	✓	✓	16	2	30	100	16	AP..1003..	M2.5X6	T08
EM90 D16 W16 L120 Z02 AP..1003..	✓	✓			30	120				
EM90 D16 W16 L150 Z02 AP..1003..	✓	✓			40	150				
EM90 D16 W16 L200 Z02 AP..1003..	✓	✓			50	200				
EM90 D16 W16 L250 Z02 AP..1003..	✓	✓			50	250				
EM90 D18 W16 L100 Z02 AP..1003..	✓	✓	18	2	30	100	16	AP..1003..	M2.5X6	T08
EM90 D18 W16 L120 Z02 AP..1003..	✓	✓			30	120				
EM90 D18 W16 L150 Z02 AP..1003..	✓	✓			40	150				
EM90 D18 W16 L200 Z02 AP..1003..	✓	✓			50	200				
EM90 D20 W20 L100 Z03 AP..1003..	✓	✓	20	3	30	100	20	AP..1003..	M2.5X7	T08
EM90 D20 W20 L120 Z03 AP..1003..	✓	✓			30	120				
EM90 D20 W20 L150 Z03 AP..1003..	✓	✓			40	150				
EM90 D20 W20 L200 Z03 AP..1003..	✓	✓			60	200				
EM90 D20 W20 L250 Z03 AP..1003..	✓	✓			70	250				
EM90 D22 W20 L100 Z03 AP..1003..	✓	✓	22	3	30	100	20	AP..1003..	M2.5X7	T08
EM90 D22 W20 L120 Z03 AP..1003..	✓	✓			30	120				
EM90 D22 W20 L150 Z03 AP..1003..	✓	✓			40	150				
EM90 D25 W25 L100 Z03 AP..1003..	✓	✓	25	3	30	100	25	AP..1003..	M2.5X8	T08
EM90 D25 W25 L120 Z03 AP..1003..	✓	✓			30	120				
EM90 D25 W25 L150 Z03 AP..1003..	✓	✓			40	150				
EM90 D25 W25 L200 Z03 AP..1003..	✓	✓			60	200				
EM90 D25 W25 L250 Z03 AP..1003..	✓	✓			70	250				
EM90 D30 W25 L100 Z04 AP..1003..	✓	✓	30	4	30	100	25	AP..1003..	M2.5X8	T08
EM90 D30 W25 L120 Z04 AP..1003..	✓	✓			30	120				
EM90 D30 W25 L150 Z04 AP..1003..	✓	✓			40	150				
EM90 D35 W25 L100 Z04 AP..1003..	✓	✓	35	4	30	100	25	AP..1003..	M2.5X8	T08
EM90 D35 W25 L120 Z04 AP..1003..	✓	✓			30	120				
EM90 D35 W25 L150 Z04 AP..1003..	✓	✓			40	150				
EM90 D35 W25 L200 Z04 AP..1003..	✓	✓			50	200				
EM90 D35 W32 L100 Z04 AP..1003..	✓	✓	35	4	35	100	32	AP..1003..	M2.5X8	T08
EM90 D35 W32 L120 Z04 AP..1003..	✓	✓			35	120				
EM90 D35 W32 L150 Z04 AP..1003..	✓	✓			35	150				
EM90 D40 W25 L100 Z05 AP..1003..	✓	✓	40	5	40	100	25	AP..1003..	M2.5X8	T08
EM90 D40 W25 L120 Z05 AP..1003..	✓	✓			40	120				
EM90 D40 W25 L150 Z05 AP..1003..	✓	✓			40	150				
EM90 D40 W25 L200 Z05 AP..1003..	✓	✓			40	200				
EM90 D40W32 L100 Z05 AP..1003..	✓	✓	40	5	40	100	32	AP..1003..	M2.5X8	T08
EM90 D40W32 L120 Z05 AP..1003..	✓	✓			40	120				
EM90 D40W32 L150 Z05 AP..1003..	✓	✓			40	150				

APKT

AP..1604

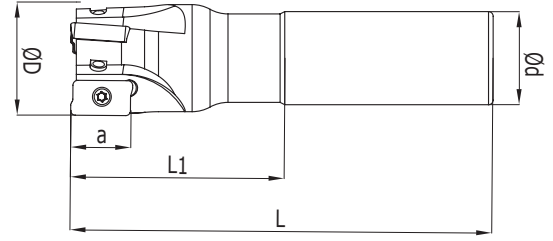

Kesici Uç Uyumluluğu Insert Suitability	Stok Stock	Inter Cooland	D	Z	H	L	d	Uç Insert	Vida Screw	Anahtar Torx Key
AP..1604..										
EM90 D25 W25 L100 Z02 AP..1604..	✓	✓	25	2	37	100	25	AP..1604..	M3.5X8	T15
EM90 D25 W25 L120 Z02 AP..1604..	✓	✓			41	120				
EM90 D25 W25 L150 Z02 AP..1604..	✓	✓			50	150				
EM90 D25 W25 L200 Z02 AP..1604..	✓	✓			70	200				
EM90 D25 W25 L250 Z02 AP..1604..	✓	✓			70	250				
EM90 D25 W25 L300 Z02 AP..1604..	✓	X			70	300				
EM90 D30 W25 L100 Z02 AP..1604..	✓	✓	30	2	41	120	25	AP..1604..	M3.5X10	T15
EM90 D30 W25 L120 Z02 AP..1604..	✓	✓			41	120				
EM90 D30 W25 L150 Z02 AP..1604..	✓	✓			41	150				
EM90 D30 W25 L200 Z02 AP..1604..	✓	✓			41	200				
EM90 D30 W25 L100 Z03 AP..1604..	✓	✓	30	3	41	120	25	AP..1604..	M3.5X10	T15
EM90 D30 W25 L120 Z03 AP..1604..	✓	✓			41	120				
EM90 D30 W25 L150 Z03 AP..1604..	✓	✓			41	150				
EM90 D30 W25 L200 Z03 AP..1604..	✓	✓			41	200				
EM90 D30 W25 L250 Z03 AP..1604..	✓	✓			41	250				
EM90 D30 W25 L300 Z03 AP..1604..	✓	X			41	300				
EM90 D32 W25 L100 Z03 AP..1604..	✓	✓	32	3	41	100	25	AP..1604..	M3.5X10	T15
EM90 D32 W25 L120 Z03 AP..1604..	✓	✓			41	120				
EM90 D32 W25 L150 Z03 AP..1604..	✓	✓			41	150				
EM90 D32 W25 L200 Z03 AP..1604..	✓	✓			41	200				
EM90 D32 W32 L100 Z02 AP..1604..	✓	✓	32	2	35	100	32	AP..1604..	M3.5X10	T15
EM90 D32 W32 L120 Z02 AP..1604..	✓	✓			35	120				
EM90 D32 W32 L150 Z02 AP..1604..	✓	✓			50	150				
EM90 D32 W32 L200 Z02 AP..1604..	✓	✓			60	200				
EM90 D32 W32 L100 Z03 AP..1604..	✓	✓	32	3	35	100	32	AP..1604..	M3.5X10	T15
EM90 D32 W32 L120 Z03 AP..1604..	✓	✓			35	120				
EM90 D32 W32 L150 Z03 AP..1604..	✓	✓			50	150				
EM90 D32 W32 L200 Z03 AP..1604..	✓	✓			60	200				
EM90 D32 W32 L250 Z03 AP..1604..	✓	✓			70	250				
EM90 D32 W32 L300 Z03 AP..1604..	✓	X			70	300				
EM90 D32 W32 L350 Z03 AP..1604..	✓	X			100	350				
EM90 D35 W25 L100 Z03 AP..1604..	✓	✓	35	3	41	100	25	AP..1604..	M3.5X10	T15
EM90 D35 W25 L120 Z03 AP..1604..	✓	✓			41	120				
EM90 D35 W25 L150 Z03 AP..1604..	✓	✓			55	150				
EM90 D35 W32 L100 Z03 AP..1604..	✓	✓	35	3	41	100	32	AP..1604..	M3.5X10	T15
EM90 D35 W32 L120 Z03 AP..1604..	✓	✓			41	120				
EM90 D35 W32 L150 Z03 AP..1604..	✓	✓			41	150				
EM90 D35 W32 L200 Z03 AP..1604..	✓	✓			41	200				
EM90 D35 W32 L250 Z03 AP..1604..	✓	✓			41	250				
EM90 D35 W32 L300 Z03 AP..1604..	✓	X			41	300				
EM90 D35 W32 L350 Z03 AP..1604..	✓	X			41	350				
EM90 D40 W25 L100 Z04 AP..1604..	✓	✓	40	4	41	100	25	AP..1604..	M3.5X10	T15
EM90 D40 W25 L120 Z04 AP..1604..	✓	✓			41	120				
EM90 D40 W25 L150 Z04 AP..1604..	✓	✓			41	150				
EM90 D40 W25 L200 Z04 AP..1604..	✓	✓			41	200				

APKT

AP..1604

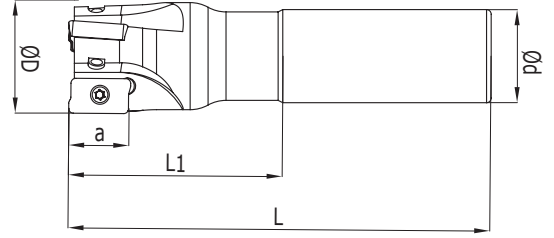

Kesici Uç Uyumluluğu Insert Suitability	Stok Stock	Inter Cooland	D	Z	H	L	d	Uç Insert	Vida Screw	Anahtar Torx Key
AP..1604..										
EM90 D40 W32 L100 Z04 AP..1604..	✓	✓	40	4	46	100	32	AP..1604..	M3.5X10	T15
EM90 D40 W32 L120 Z04 AP..1604..	✓	✓			46	120				
EM90 D40 W32 L150 Z04 AP..1604..	✓	✓			46	150				
EM90 D40 W32 L200 Z04 AP..1604..	✓	✓			46	200				
EM90 D40 W32 L250 Z04 AP..1604..	✓	✓			46	250				
EM90 D40 W32 L300 Z04 AP..1604..	✓	X			46	300				
EM90 D40 W32 L350 Z04 AP..1604..	✓	X			46	350				



APMT

11T3

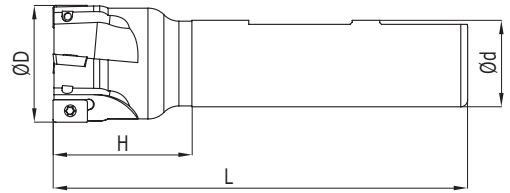

Kesici Uç Uyumluluğu Insert Suitability	Stok Stock	Inter Cooland	D	Z	L1	L	d	Uç Insert	Vida Screw	Anahtar Torx Key
APMT 11T3..										
EM90 D16W16 L90 Z02 APMT 11T3..	✓	X	16	2	30	90	16	APMT 11T3..	M2.5X6	T08
EM90 D16W16 L120 Z02 APMT 11T3..	✓	X	16	2	30	120	16			
EM90 D16W16 L150 Z02 APMT 11T3..	✓	X	16	2	40	150	16			
EM90 D17W16 L120 Z02 APMT 11T3..	✓	X	17	2	30	120	16			
EM90 D18W16 L100 Z02 APMT 11T3..	✓	X	18	2	30	150	16			
EM90 D20W20 L100 Z03 APMT 11T3..	✓	X	20	3	30	100	20			
EM90 D20W20 L120 Z03 APMT 11T3..	✓	X	20	3	30	120	20			
EM90 D20W20 L150 Z03 APMT 11T3..	✓	X	20	3	40	150	20			
EM90 D21W20 L140 Z03 APMT 11T3..	✓	X	21	3	40	140	20			
EM90 D22W20 L120 Z03 APMT 11T3..	✓	X	22	3	40	120	20			
EM90 D25W25 L120 Z03 APMT 11T3..	✓	X	25	3	30	120	25			
EM90 D25W25 L150 Z03 APMT 11T3..	✓	X	25	3	40	150	25			
EM90 D30W25 L120 Z04 APMT 11T3..	✓	X	30	4	30	120	25			
EM90 D30W25 L150 Z04 APMT 11T3..	✓	X	30	4	40	150	25			



XO..0903

SCO

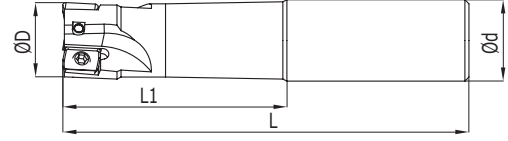

Kesici Uç Uyumluluğu Insert Suitability	Stok Stock	Inter Cooland	D	Z	L1	L	d	Uç Insert	Vida Screw	Anahtar Torx Key
SCO XO..0903..										
EM90 D16 W16 L100 Z02 XO..0903..	✓	X	16	2	30	100	16	XO..0903..	M2.5X8	T08
EM90 D16 W16 L130 Z02 XO..0903..	✓	X	16	2	30	130	16			
EM90 D16 W16 L150 Z02 XO..0903..	✓	X	16	2	40	150	16			
EM90 D16 W16 L200 Z02 XO..0903..	✓	X	16	2	50	200	16			
EM90 D20 W20 L120 Z03 XO..0903..	✓	X	20	3	30	120	20	XO..0903..	M2.5X8	T08
EM90 D20 W20 L150 Z03 XO..0903..	✓	X	20	3	40	150	20			
EM90 D20 W20 L200 Z03 XO..0903..	✓	X	20	3	50	200	20			

XOMX 1204

SCO

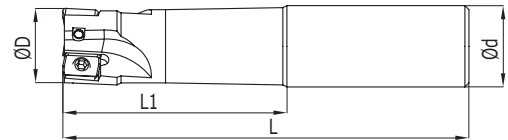

Kesici Uç Uyumluluğu Insert Suitability	Stok Stock	Inter Cooland	D	Z	L1	L	d	Uç Insert	Vida Screw	Anahtar Torx Key
SCO XOMX 1204..										
EM90 D16 W16 L120 Z01 XOMX 1204..	✓	X	16	1	30	120	16	XOMX 1204..	M3,5X6	T15
EM90 D16 W16 L150 Z01 XOMX 1204..	✓	X			40	150				
EM90 D20 W20 L120 Z02 XOMX 1204..	✓	X	20	2	30	120	20	XOMX 1204..	M3,5X6	T15
EM90 D20 W20 L150 Z02 XOMX 1204..	✓	X			40	150				
EM90 D25 W25 L120 Z03 XOMX 1204..	✓	X	25	3	40	120	25	XOMX 1204..	M3,5X8	T15
EM90 D25 W25 L150 Z03 XOMX 1204..	✓	X			50	150				

QXMT

QXMT 17

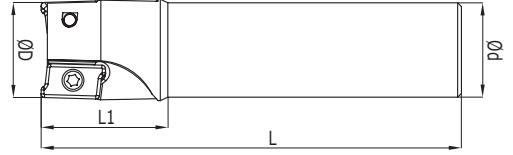

Kesici Uç Uyumluluğu Insert Suitability	Stok Stock	Inter Cooland	D	Z	L1	L	d	Uç Insert	Vida Screw	Anahtar Torx Key
ISO										
EM 90 D25W25 L150 Z02 QXMT 17	✓	X	25	2	70	150	25	QXMT 17	M4X8	T15
EM 90 D28W25 L150 Z02 QXMT 17	✓	X	28	2	50	150	25			
EM 90 D35W25 L150 Z03 QXMT 17	✓	X	35	3	50	150	25			



WDKT

HIGH END MILLS

WDKT

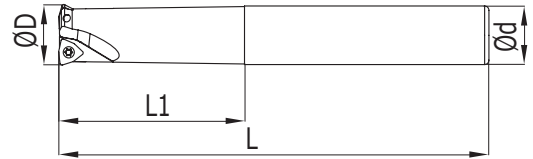

Kesici Uç Uyumluluğu Insert Suitability	Stok Stock	Inter Cooland	D	Z	L1	L	d	Uç Insert	Vida Screw	Anahtar Torx Key
ISO										
WDKT D25W25 L150 Z02 WDKT 08..	✓	X	25	2	70	150	25	WDKT 08..	M3X8	T10
WDKT D32W32 L150 Z03 WDKT 08..	✓	X	32	3	70	150	32			



LNMT

END MILLS

LNMT 08C

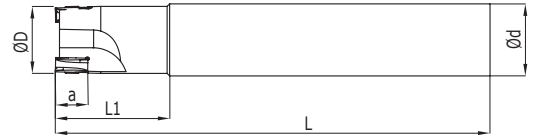

Kesici Uç Uyumluluğu Insert Suitability	Stok Stock	Inter Cooland	D	Z	L1	L	d	Uç Insert	Vida Screw	Anahtar Torx Key
ISCR LNMT 0804..										
EM 90 D16W16 L120 Z02 LNMT 0804..	✓	X	16	2	30	120	16	LNMT 0804..	M2.5X6	T08
EM 90 D18W20 L120 Z02 LNMT 0804..	✓	X	18	2	40	120	20			
EM 90 D20W20 L120 Z03 LNMT 0804..	✓	X	20	3	40	120	20			
EM 90 D25W25 L150 Z04 LNMT 0804..	✓	X	25	4	40	150	25			
EM 90 D30W25 L150 Z04 LNMT 0804..	✓	X	30	4	40	150	25			
EM 90 D32W32 L200 Z04 LNMT 0804..	✓	X	30	4	37	200	25			



LNMX..

LNMX



Kesici Uç Uyumluluğu Insert Suitability	Stok Stock	Inter Cooland	D	Z	L1	L	d	Uç Insert	Vida Screw	Anahtar Torx Key
KRLY LNMX 1006								LNMX 1006..	M3X6	T10
EM 90 D16W16 L90 Z01 LNMX 1006..	✓	✓	16	1	30	90	16			
EM 90 D18W16 L90 Z01 LNMX 1006..	✓	✓	18	1	30	90	18			
EM 90 D20W20 L100 Z02 LNMX 1006..	✓	✓	20	2	30	100	20			
EM 90 D20W20 L150 Z02 LNMX 1006..	✓	✓	20	2	50	150	20			
EM 90 D25W25 L115 Z02 LNMX 1006..	✓	✓	25	2	30	115	25			
EM 90 D25W25 L115 Z03 LNMX 1006..	✓	✓	25	3	30	115	25			
EM 90 D25W25 L150 Z03 LNMX 1006..	✓	✓	25	3	50	150	25			
EM 90 D32W32 L125 Z03 LNMX 1006..	✓	✓	32	3	50	125	32			
EM 90 D32W32 L125 Z04 LNMX 1006..	✓	✓	32	4	50	125	32			
EM 90 D40W32 L130 Z04 LNMX 1006..	✓	✓	40	4	40	130	32			

T FREZE - T MILLINGS

CCMT

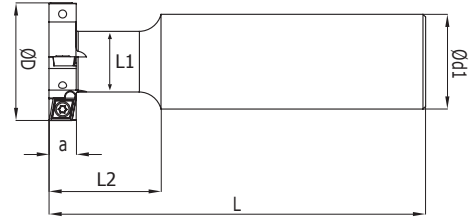

Kesici Uç Uyumluluğu Insert Suitability	Stok Stock	D	Z	a	L	L1	L2	d1	Uç Insert	Vida Screw	Anahtar Torx Key		
ISO									CC.. 0602..	M2,5X7	T08		
TF90 D17X8 W16 Z02 CC.. 0602..	✓	17	2	8	100	8	19	25					
TF90 D20X9 W16 Z02 CC.. 0602..	✓	20	2	9	100	10	20	25					
TF90 D21X9 W16 Z02 CC.. 0602..	✓	21	2	9	100	10	20	25					
TF90 D24X10 W20 Z02 CC.. 0602..	✓	24	2	10	100	12	24	25					
TF90 D25X11 W22 Z02 CC.. 0602..	✓	25	2	11	100	12	29	25					
TF90 D25X12 W25 Z02 CC.. 0602..	✓	25	2	12	100	12	29	25					
TF90 D32X8 W25 Z04 CC.. 0602..	✓	32	4	8	100	16	24	25					
TF90 D32X10 W25 Z04 CC.. 0602..	✓	32	4	10	100	16	29	25					
TF90 D63X8 W32 Z08 CC.. 0602..	✓	63	8	8	125	31	40	32					
TF90 D30X12 W25 Z02 CC.. 09T3..	✓	30	2	12	100	16	29	25	CC.. 09T3..	M3,5X8	T15		
TF90 D32X12 W25 Z02 CC.. 09T..	✓	32	2	12	100	16	29	25					
TF90 D32X14 W25 Z02 CC.. 09T3..	✓	32	2	14	100	16	29	25					
TF90 D40X12 W32 Z04 CC.. 09T3..	✓	40	4	12	120	18	32	40					
TF90 D40X16 W32 Z04 CC.. 09T3..	✓	40	4	16	120	18	32	32					
TF90 D40X18 W32 Z04 CC.. 09T3..	✓	40	4	18	120	18	32	32					
TF90 D50X12 W32 Z04 CC.. 09T3..	✓	50	4	12	120	31	35	32					
TF90 D50X16 W32 Z04 CC.. 09T3..	✓	50	4	16	120	31	35	32					
												M3,5X9	T16

KÜRE ŞAFTLI TARAMA - BALL NOSE END MILLS

ROHX

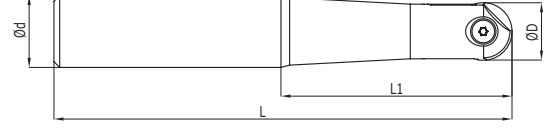

Kesici Uç Uyumluluğu Insert Suitability	Stok Stock	D	d	L1	L	Uç Insert	Vida Screw	Anahtar Torx Key
ZCC2								
BBMR D12W16 L130 ROHX 1203	✓	12	16	45	130	ROHX 1203	M4X0,5X9	T15
BBMR D16W20 L190 ROHX 1604	✓	16	20	60	190	ROHX 1604	M5X0,5X10	T20
BBMR D20W25 L240 ROHX 2005	✓	16	25	60	240	ROHX 2005	M5X0,5X13	T20



KÜRE ŞAFTLI TARAMA - BALL NOSE END MILLS

ZOHX

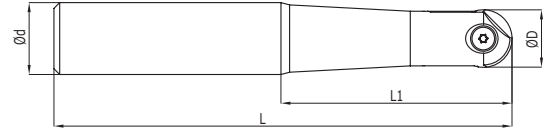





Kesici Uç Uyumluluğu Insert Suitability	Stok Stock	D	d	L1	L	Uç Insert	Vida Screw	Anahtar Torx Key
ZCC2								
BBMR D12W16 L150 ZOHX 1203	✓	12	16	45	150	ZOHX 1203	M4X0,5X9	T15
BBMR D16W16 L180 ZOHX 1203	✓	16	16	60	180	ZOHX 1604	M5X0,5X10	T20
BBMR D20W20 L200 ZOHX 1203	✓	20	20	60	200	ZOHX 2005	M5X0,5X13	T20
BBMR D25W25 L250 ZOHX 2506	✓	25	25	60	250	ZOHX 2506	M6X0,75X17	T20

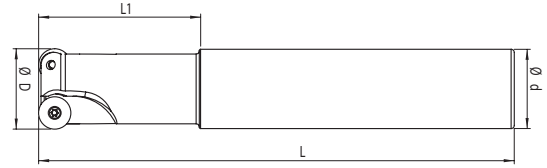

RD.. END MILLS

RD..





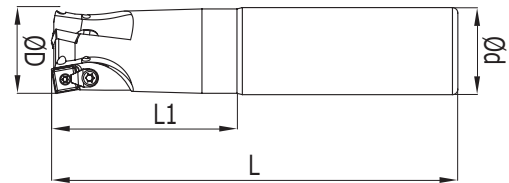

Kesici Uç Uyumluluğu Insert Suitability	Stok Stock	Inter Cooland	D	Z	L1	L	d			
								Uç Insert	Vida Screw	Anahtar Torx Key
EMR D10W10 L100 Z02 RD..0501	✓	X	10	2	30	100	10	RD..0501	M2X5	T06
EMR D12W12 L100 Z02 RD..0501	✓	X	12	2	30	100	12			
EMR D16W16 L150 Z02 RD..0803	✓	X	16	2	50	150	16	RD..1003	M3X6	T10
EMR D20W20 L120 Z02 RD..1003	✓	✓	20	2	35	120	20		M3,5X6	T15
EMR D20W20 L150 Z02 RD..1003	✓	✓	20	2	50	150	20			
EMR D25W25 L150 Z02 RD..1003	✓	✓	25	2	50	150	25			
EMR D25W25 L200 Z02 RD..1003	✓	✓	25	2	70	200	25			
EMR D32W32 L150 Z03 RD..1003	✓	✓	32	3	70	150	32			
EMR D32W32 L250 Z02 RD..1003	✓	X	32	2	100	250	32			
EMR D32W32 L250 Z03 RD..1003	✓	X	32	3	100	250	32			
EMR D40W32 L150 Z02 RD..1003	✓	X	40	2	70	150	32			
EMR D40W32 L150 Z04 RD..1003	✓	X	40	4	70	150	32			
EMR D40W32 L250 Z02 RD..1003	✓	X	40	2	100	250	32			
EMR D40W32 L250 Z04 RD..1003	✓	X	40	4	100	250	32			
EMR D20W20 L150 Z02 RD..10T3	✓	X	20	2	50	150	20	RD..10T3	M3,5X6	T15
EMR D25W25 L150 Z02 RD..10T3	✓	X	25	2	50	150	25			
EMR D25W25 L200 Z02 RD..10T3	✓	X	25	2	70	200	25			
EMR D32W32 L250 Z02 RD..10T3	✓	X	32	2	100	250	32			
EMR D40W32 L150 Z04 RD..10T3	✓	X	40	4	70	150	32			
EMR D40W32 L250 Z02 RD..10T3	✓	X	40	2	100	250	32			
EMR D40W32 L250 Z04 RD..10T3	✓	X	40	4	100	250	32			

SDMT HIGH END MILLS

SDMT



Kesici Uç Uyumluluğu Insert Suitability	Stok Stock	Inter Cooland	D	Z	L1	L	d						Uç Tipi Insert Type
								Uç Insert	Vida Screw	Pabuç Clamp	Vida Screw	Anahtar Torx Key	
EMRC D25W25 L150 Z02 SDMT 09T312	✓	✓	25	2	70	150	25	SDMT 09T312	M3,5X8	CK14	M3,5X10	T15	ZCC
EMRC D32W32 L150 Z03 SDMT 09T312	✓	✓	32	3	70	150	32						
EMRC D25W25 L150 Z02 SDMT 09T312	✓	✓	25	2	70	150	25						
EMRC D32W32 L150 Z03 SDMT 09T312	✓	✓	32	3	70	150	32						

ADKX

ADKX

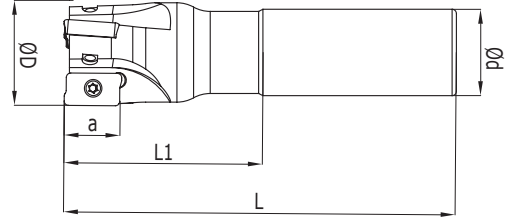

Kesici Uç Uyumluluğu Insert Suitability	Stok Stock
LMT FTTE ADKX 1204..	
EM 90 D12W12 L80 Z01 ADKX 1204..	✓
EM 90 D16W14 L140 Z02 ADKX 1204..	✓
EM 90 D16W16 L140 Z02 ADKX 1204..	✓
EM 90 D20W18 L91 Z02 ADKX 1204..	✓
EM 90 D20W20 L91 Z02 ADKX 1204..	✓
EM 90 D20W20 L171 Z02 ADKX 1204..	✓
EM 90 D25W20 L171 Z03 ADKX 1204..	✓
EM 90 D25W25 L100 Z02 ADKX 1204..	✓
EM 90 D25W25 L100 Z03 ADKX 1204..	✓
EM 90 D25W25 L171 Z02 ADKX 1204..	✓
EM 90 D32W32 L111 Z03 ADKX 1204..	✓
EM 90 D32W32 L201 Z04 ADKX 1204..	✓

Inter Cooland	D	Z	L1	L	d	Uç Insert	Vida Screw	Anahtar Torx Key
X	12	1	30	80	12	ADKX 1204..	M3X6	T10
X	16	2	40	140	14			
X	16	2	40	140	16			
X	20	2	30	91	18			
X	20	2	40	91	20			
X	20	2	50	171	20			
X	25	3	40	171	20		M3X8	
X	25	2	45	100	25			
X	25	3	45	100	25			
X	25	2	50	171	25			
X	32	3	50	111	32			
X	32	4	70	201	32			

TPKN

TPKN

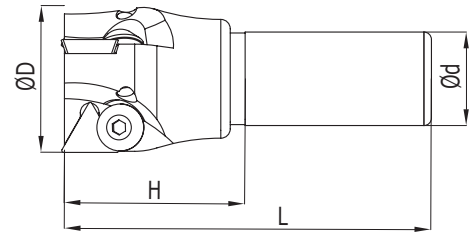

Kesici Uç Uyumluluğu Insert Suitability	Stok Stock
ISO	
EM 90 D35W25 L100 Z02	✓
EM 90 D40W25 L100 Z03	✓
EM 90 D50W25 L100 Z03	✓

Inter Cooland	D	Z	L1	L	d	Uç Insert	Vida Screw	Anahtar Torx Key
X	35	2	50	100	25	TPKN 1603	M6X0,75	A4
X	40	3	50	100	25			
X	50	3	50	100	25			

APKT 1003

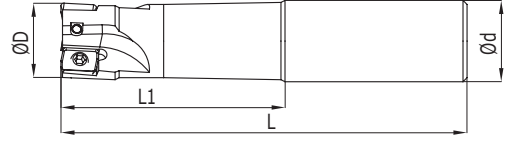

Kesici Uç Uyumluluğu Insert Suitability	Stok Stock	Inter Cooland	D	Z	H	L	d	Uç Insert	Vida Screw	Anahtar Torx Key
PLBT APKT 1003..										
EM90 D16 W16 L120 Z01 APKT 1003..	X	X	16	2	30	120	16	APKT 1003..	M2.5X6	T08
EM90 D16 W16 L150 Z01 APKT 1003..	X	X	16	2	40	150	16			
EM90 D20 W20 L120 Z02 APKT 1003..	X	X	20	2	30	120	20	APKT 1003..	M2.5X7	T08
EM90 D20 W20 L150 Z02 APKT 1003..	X	X	20	2	40	150	20			
EM90 D25 W25 L120 Z03 APKT 1003..	X	X	25	3	30	120	25	APKT 1003..	M2.5X8	T08
EM90 D25 W25 L150 Z03 APKT 1003	X	X	25	3	40	150	25			

ADMX 11T3

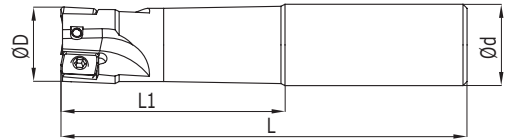

Kesici Uç Uyumluluğu Insert Suitability	Stok Stock	Inter Cooland	D	Z	H	L	d	Uç Insert	Vida Screw	Anahtar Torx Key
PRMT ADMX 11T3										
EM90 D12 W12 L120 Z01 ADMX 11T3..	✓	X	12	1	40	120	12	ADMX 11T3..	M2,5X5	T08
EM90 D16 W16 L150 Z02 ADMX 11T3..	✓	X	16	2	50	150	16		M2,5X6	
EM90 D20 W20 L150 Z03 ADMX 11T3..	✓	X	20	3	50	150	20			
EM90 D25 W25 L200 Z03 ADMX 11T3..	✓	X	25	3	70	200	25			
EM90 D32 W32 L200 Z04 ADMX 11T3..	✓	X	32	4	75	200	32		M2,5X7	

LNGX 1205

END MILLS

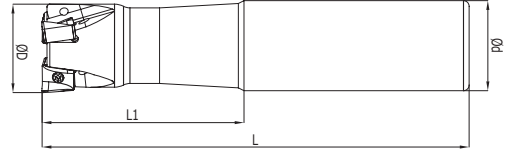

Kesici Uç Uyumluluğu Insert Suitability	Stok Stock	Inter Cooland	D	Z	H	L	d	Uç Insert	Vida Screw	Anahtar Torx Key
PRMT / VNDRT LNGX 1205										
EM90 D25W25 L150 Z03 LNGX 1205..	✓	x	25	3	50	150	25	LNGX 1205..	M3,5X10	T15
EM90 D32W32 L150 Z03 LNGX 1205..	✓	x	32	3	50	125	32			



SP..08T308

HIGH END MILLS

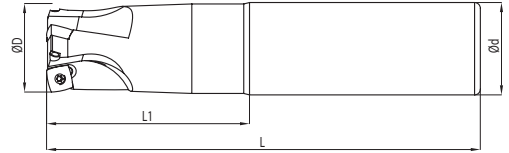

Kesici Uç Uyumluluğu Insert Suitability	Stok Stock	Inter Cooland	D	Z	H	L	d	Uç Insert	Vida Screw	Pabuç Clamp	Vida Screw	Anahtar Torx Key
PLBT												
EMR D20W20 L150 Z02 SP..09T308	x	x	20	2	60	150	20	SP..09T308	M3X8	CK14	M3X10	T10
EMR D25W25 L150 Z03 SP..09T308	x	x	25	3	70	150	25					



WNMX 09T3

HIGH END MILLS



Kesici Uç Uyumluluğu Insert Suitability	Stok Stock	Inter Cooland	D	Z	H	L	d	Uç Insert	Vida Screw	Anahtar Torx Key
WNMX 09T3 KRLY								WNMX 09T3	M3X8	T10
EMR D25W25 L150 Z02 WNMX 09T3	✓	✓	25	2	70	150	25			
EMR D32W32 L150 Z03 WNMX 09T3	✓	✓	32	3	70	150	32			

XD..11

END MILLS

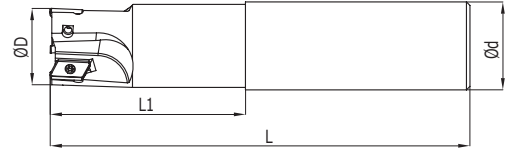

Kesici Uç Uyumluluğu Insert Suitability	Stok Stock	Inter Cooland	D	Z	H	L	d	Uç Insert	Vida Screw	Anahtar Torx Key
CRTZT								XD..11..	M2.5X6	T08
EM90 D16 W16 L150 Z02 XD..11	x	x	16	2	50	150	16			
EM90 D20 W20 L150 Z03 XD..11..	x	x	20	3	50	150	20			
EM90 D25 W25 L150 Z03 XD..11..	x	x	25	3	50	150	25			

ZDCW 09T3

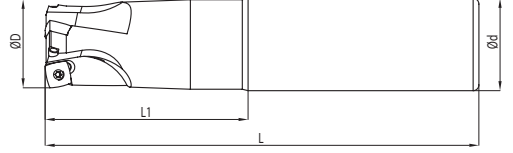

Kesici Uç Uyumluluğu Insert Suitability	Stok Stock	Inter Cooland	D	Z	H	L	d	Uç Insert	Vida Screw	Pabuç Clamp	Vida Screw	Anahtar Torx Key
PRMT												
EMRC D20W20 L150 Z02 ZDCW 09T3..	✓	✓	20	2	60	150	20	ZDCW 09T3..	M3X8	CK14	M3,5X10	T15
EMRC D25W25 L150 Z02 ZDCW 09T3..	✓	✓	25	2	70	150	25					
EMRC D32W32 L150 Z03 ZDCW 09T3..	✓	✓	32	3	70	150	32					

WOEJ 0804

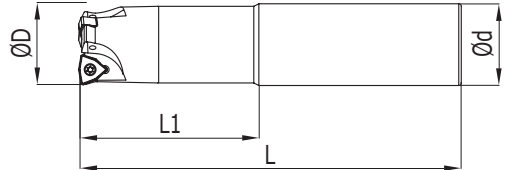

Kesici Uç Uyumluluğu Insert Suitability	Stok Stock	Inter Cooland	D	Z	H	L	d	Uç Insert	Vida Screw	Anahtar Torx Key
WOEJ 0804 WDA										
EMR D25W25 L150 Z02 WOEJ 0804	X	✓	25	2	60	150	25	WOEJ 0804	M3X8	T10
EMR D25W25 L200 Z02 WOEJ 0804	X	✓	25	2	80	200	25			
EMR D32W32 L150 Z03 WOEJ 0804	X	✓	32	3	60	150	32			
EMR D32W32 L200 Z03 WOEJ 0804	X	✓	32	3	80	200	32			

ADMT 1204 WLTR

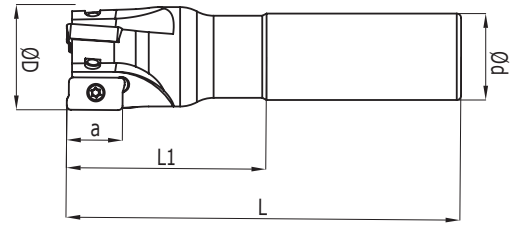

Kesici Uç Uyumluluğu Insert Suitability	Stok Stock
ADMT 1204. WLTR	
EM90 D20 W20 L120 Z02 ADMT 1204..	✓
EM90 D20 W20 L150 Z02 ADMT 1204..	✓
EM90 D25 W25 L120 Z03 ADMT 1204..	✓
EM90 D25 W25 L150 Z03 ADMT 1204..	✓
EM90 D30 W25 L120 Z03 ADMT 1204..	✓
EM90 D30 W25 L150 Z03 ADMT 1204..	✓
EM90 D40 W32 L120 Z04 ADMT 1204..	✓
EM90 D40 W32 L150 Z04 ADMT 1204..	✓

Inter Cooland	D	Z	L1	L	d
X	20	2	35	100	20
X	20	2	50	150	20
X	25	3	35	120	25
X	25	3	50	150	25
X	30	3	35	120	25
X	30	3	50	150	25
X	40	4	35	120	32
X	40	4	50	150	32



Uç
Insert

Vida
Screw

Anahtar
Torx Key

ADMT 1204..

M3X9

T10

ADMT 10T3 WLTR

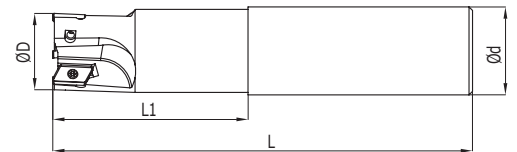

Kesici Uç Uyumluluğu Insert Suitability	Stok Stock
ADMT 10T3.. WLTR	
EM90 D16 W16 L90 Z02 ADMT 10T3..	X
EM90 D20 W20 L120 Z03 ADMT 10T3..	X
EM90 D25 W25 L120 Z03 ADMT 10T3..	X

Inter Cooland	D	Z	L1	L	d
X	16	2	25	90	16
X	20	3	35	120	20
X	25	3	35	120	25



Uç
Insert

Vida
Screw

Anahtar
Torx Key

ADMT 10T3..

M2.5X6

T08

ANKX 1205 ISCR

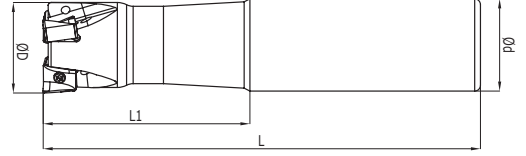

Kesici Uç Uyumluluğu Insert Suitability	Stok Stock	Inter Cooland	D	Z	L1	L	d	Uç Insert	Vida Screw	Anahtar Torx Key
ISCR ANKX 1205..								ANKX 1205..		
EM90 D30 W25 L120 Z02 ANKX 1205..	✓	✓	30	3	40	120	25	ANKX 1205..	M4X11	T15
EM90 D30 W25 L150 Z02 ANKX 1205..	✓	✓	30	3	40	150	25			
EM90 D35 W32 L120 Z03 ANKX 1205..	✓	✓	35	3	40	120	32	ANKX 1205..	M4X11	T15
EM90 D35 W32 L150 Z03 ANKX 1205..	✓	✓	35	3	40	150	32			

AP..0903 WLTR

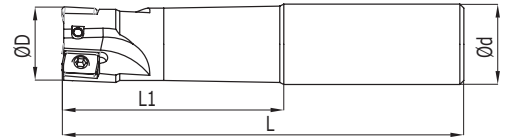

Kesici Uç Uyumluluğu Insert Suitability	Stok Stock	Inter Cooland	D	Z	L1	L	d	Uç Insert	Vida Screw	Anahtar Torx Key
AP..0903 WLTR								AP..0903..		
EM90 D16 W16 L100 Z02 AP..0903..	✓	X	16	2	30	100	16	AP..0903..	M2.5X8	T08
EM90 D16 W16 L130 Z02 AP..0903..	✓	X	16	2	30	130	16			
EM90 D16 W16 L150 Z02 AP..0903..	✓	X	16	2	40	150	16			
EM90 D16 W16 L200 Z02 AP..0903..	✓	X	16	2	50	200	16	AP..0903..	M2.5X8	T08
EM90 D20 W20 L120 Z03 AP..0903..	✓	X	20	3	30	120	20			
EM90 D20 W20 L150 Z03 AP..0903..	✓	X	20	3	40	150	20			
EM90 D20 W20 L200 Z03 AP..0903..	✓	X	20	3	50	200	20			

APCT 1135 KLP

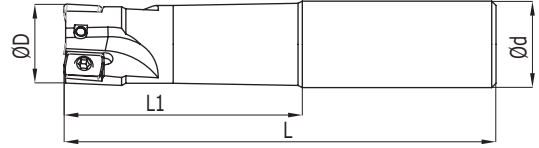

Kesici Uç Uyumluluğu Insert Suitability	Stok Stock	Inter Cooland	D	Z	L1	L	d	Uç Insert	Vida Screw	Anahtar Torx Key
KLP APCT 1135										
EM90 D16 W16 L100 Z02 APCT 1135..	✓	✓	16	2	30	100	16	APCT 1135..	M2.5X6	T08
EM90 D16 W16 L120 Z02 APCT 1135..	✓	✓	16	2	30	120	16			
EM90 D16 W16 L150 Z02 APCT 1135..	✓	✓	16	2	40	150	16			
EM90 D18 W16 L150 Z02 APCT 1135..	✓	✗	18	2	40	150	16			
EM90 D20 W20 L100 Z02 APCT 1135..	✓	✓	20	3	30	100	20	APCT 1135..	M2.5X7	T08
EM90 D20 W20 L120 Z02 APCT 1135..	✓	✓	20	3	30	120	20			
EM90 D20 W20 L150 Z02 APCT 1135..	✓	✓	20	3	40	150	20			
EM90 D22 W20 L150 Z03 APCT 1135..	✓	✗	22	3	40	150	20			
EM90 D25 W25 L100 Z03 APCT 1135..	✓	✓	25	3	30	100	25	APCT 1135..	M2.5X8	T08
EM90 D25 W25 L120 Z03 APCT 1135..	✓	✓	25	3	30	120	25			
EM90 D25 W25 L150 Z03 APCT 1135..	✓	✓	25	3	40	150	25			
EM90 D27 W25 L150 Z03 APCT 1135..	✓	✗	27	3	40	150	25			
EM90 D32 W32 L120 Z04 APCT 1135..	✓	✓	32	4	30	120	32	APCT 1135..	M2.5X8	T08
EM90 D32 W32 L150 Z04 APCT 1135..	✓	✓	32	4	40	150	32			
EM90 D35 W32 L150 Z04 APCT 1135..	✓	✗	35	4	40	150	32			

APKT 1003 KLP

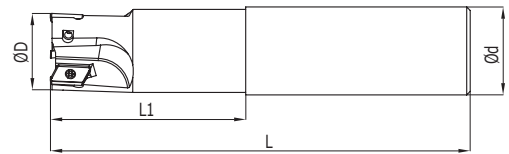

Kesici Uç Uyumluluğu Insert Suitability	Stok Stock	Inter Cooland	D	Z	L1	L	d	Uç Insert	Vida Screw	Anahtar Torx Key
APKT 1003.. KLP										
EM90 D16 W16 L150 Z02 APKT 1003..	✓	✗	16	2	40	150	16	APKT 1003..	M2.5X6	T08
EM90 D18 W16 L150 Z02 APKT 1003..	✓	✗	18	2	40	150	16			
EM90 D20 W20 L150 Z03 APKT 1003..	✓	✗	20	3	40	150	20			
EM90 D22 W20 L150 Z03 APKT 1003..	✓	✗	22	3	40	150	20			
EM90 D25 W25 L150 Z03 APKT 1003..	✓	✗	25	3	40	150	25			
EM90 D27 W25 L150 Z03 APKT 1003..	✓	✗	27	3	40	150	25			
EM90 D35 W32 L150 Z04 APKT 1003..	✓	✗	35	4	40	150	32	M2.5X8		

APXT 1003 KLP

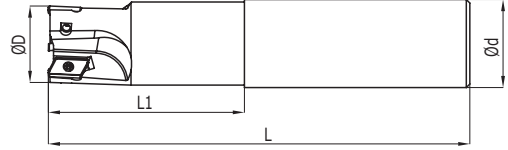

Kesici Uç Uyumluluğu Insert Suitability	Stok Stock	Inter Cooland	D	Z	L1	L	d	Uç Insert	Vida Screw	Anahtar Torx Key
APXT 1003.. KLP								APXT 1003..	M2.5X6	T08
EM90 D16 W16 L100 Z02 APXT 1003..	✓	X	16	2	30	100	16			
EM90 D16 W16 L120 Z02 APXT 1003..	✓	X	16	2	30	120	16			
EM90 D16 W16 L150 Z02 APXT 1003..	✓	X	16	2	40	150	16			
EM90 D18 W16 L150 Z02 APXT 1003..	✓	X	18	2	40	150	16			
EM90 D20 W20 L100 Z03 APXT 1003..	✓	X	20	3	30	100	20			
EM90 D20 W20 L120 Z03 APXT 1003..	✓	X	20	3	30	120	20			
EM90 D20 W20 L150 Z03 APXT 1003..	✓	X	20	3	40	150	20			
EM90 D22 W20 L150 Z03 APXT 1003..	✓	X	22	3	40	150	20			
EM90 D25 W25 L100 Z03 APXT 1003..	✓	X	25	3	30	100	25			
EM90 D25 W25 L120 Z03 APXT 1003..	✓	X	25	3	30	120	25			
EM90 D25 W25 L150 Z03 APXT 1003..	✓	X	25	3	40	150	25			
EM90 D27 W25 L150 Z03 APXT 1003..	✓	X	27	3	40	150	25			
EM90 D35 W32 L150 Z04 APXT 1003..	✓	X	35	4	40	150	32			

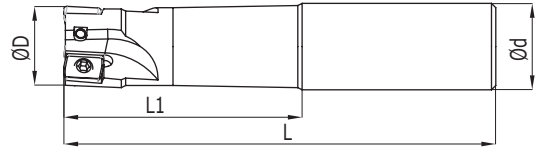

BDMT 1103 WDA



Kesici Uç Uyumluluğu Insert Suitability	Stok Stock	Inter Cooland	D	Z	L1	L	d	Uç Insert	Vida Screw	Anahtar Torx Key
BDMT 1103.. WDA								BDMT 1103..	M2.5X6	T08
EM90 D16 W16 L120 Z02 BDMT 1103..	✓	X	16	2	30	120	16			
EM90 D16 W16 L150 Z02 BDMT 1103..	✓	X	16	2	40	150	16			
EM90 D20 W20 L120 Z03 BDMT 1103..	✓	X	20	3	30	120	20			
EM90 D20 W20 L150 Z03 BDMT 1103..	✓	X	20	3	40	150	20			
EM90 D25 W25 L120 Z03 BDMT 1103..	✓	X	25	3	30	120	25			
EM90 D25 W25 L150 Z03 BDMT 1103..	✓	X	25	3	40	150	25			

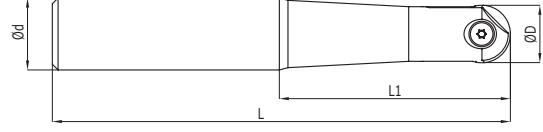

KÜRE UÇLU WLTR

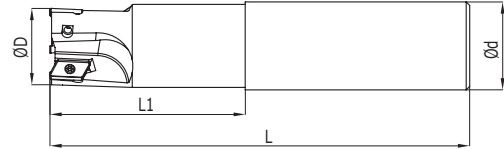

Kesici Uç Uyumluluğu Insert Suitability	Stok Stock								
		Inter Cooland	D	Z	H	d	Uç Insert	Vida Screw	Anahtar Torx Key
P3201 WLTR									
BBMR D08W10 L110 P3201-D08	✓	X	8	10	25	110	P3201-D08		T08
BBMR D10W12 L130 P3201-D10	✓	X	10	12	30	130	P3201-D10		T15
BBMR D12W12 L130 P3201-D12	✓	X	12	12	32	130	P3201-D12		T20
BBMR D16W16 L140 P3201-D16	✓	X	16	16	36	140	P3201-D16		T20
BBMR D20W20 L160 P3201-D20	✓	X	20	20	45	160	P3201-D20		T20
BBMR D25W25 L160 P3201-D25	✓	X	25	25	45	160	P3201-D25		T20
BBMR D30W32 L175 P3201-D30	✓	X	30	32	60	175	P3201-D30		T30
BBMR D32W32 L175 P3201-D32	✓	X	32	32	60	175	P3201-D32		T30

ZPMT 1003 DJET



Kesici Uç Uyumluluğu Insert Suitability	Stok Stock									
		Inter Cooland	D	Z	L1	L	d	Uç Insert	Vida Screw	Anahtar Torx Key
ZPMT 1003.. DJET										
EM90 D16 W16 L160 Z02 ZPMT 1003..	✓	X	16	2	40	160	16	ZPMT 1003..	M2.5X8	T08
EM90 D20 W20 L160 Z02 ZPMT 1003..	✓	X	20	3	50	160	20			
EM90 D20 W20 L180 Z02 ZPMT 1003..	✓	X	20	3	50	180	20			
EM90 D25 W25 L160 Z04 ZPMT 1003..	✓	X	25	4	60	160	25			
EM90 D25 W25 L200 Z04 ZPMT 1003..	✓	X	25	4	60	200	25			
EM90 D32 W32 L200 Z04 ZPMT 1003..	✓	X	32	4	70	200	32			



Siz üretirken biz destek oluyoruz / We support while you produce

MBC www.baydarlar.com



TARAMA KAFALARI- FACE MILLING

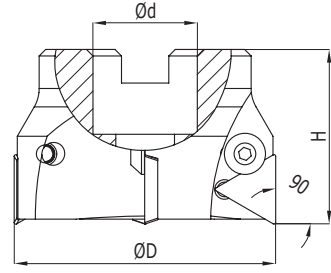

90° TPKN 16

TPKN





Kesici Uç Uyumluluğu Insert Suitability	Stok Stock	Inter Cooland	D	Z	H	d			
							Uç Insert	Vida Screw	Anahtar Allen Key
EM90 50X3 022 TP..1603..	✓	X	50	3	41	22	TP..1603..	M6X0,75	A4
EM90 63X4 022 TP..1603..	✓	X	63	4	48	22			
EM90 80X5 032 TP..1603..	✓	X	80	5	52	32			
EM90 100X6 032 TP..1603..	✓	X	100	6	52	32			

90° TPKN 22

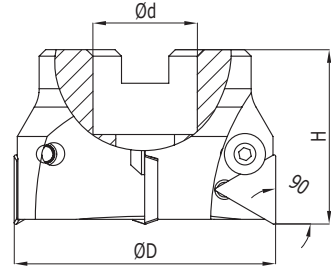
TPKN



Kesici Uç Uyumluluğu Insert Suitability	Stok Stock	Inter Cooland	D	Z	H	d			
							Uç Insert	Vida Screw	Anahtar Allen Key
EM90 63X3 022 TP..2204..	✓	X	63	3	48	22	TP.. 2204..	M8X1	A5
EM90 80X4 027 TP..2204..	✓	X	80	4	52	27			
EM90 80X4 032 TP..2204..	✓	X	80	4	52	32			
EM90 100X5 032 TP..2204..	✓	X	100	5	52	32			
EM90 125X6 040 TP..2204..	✓	X	125	6	62	40			
EM90 125X6 032 TP..2204..	✓	X	125	6	62	32			
EM90 160X7 040 TP..2204..	✓	X	160	7	62	40			
EM90 200X8 060 TP..2204..	✓	X	200	8	62	60			
EM90 250X10 060 TP..2204..	✓	X	250	10	62	60			

90° AP..1003

AP..

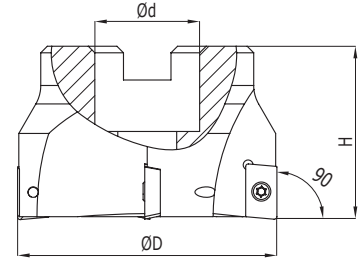

Kesici Uç Uyumluluğu Insert Suitability	Stok Stock	Inter Cooland	D	Z	H	d	AP..1003		
							Uç Insert	Vida Screw	Anahtar Allen Key
AP..1003 ISO									
EM90 40X5 016 AP..1003	✓	✓	40	5	45	16	AP..1003	M2.5X7	T08
EM90 50X6 016 AP..1003	✓	✓	50	6	45	22			
EM90 63X7 016 AP..1003	✓	✓	63	7	45	22			
EM90 80X8 016 AP..1003	✓	✓	80	8	52	27			
EM90 100X9 016 AP..1003	✓	✓	100	9	52	32			

90° APKT 16

APKT

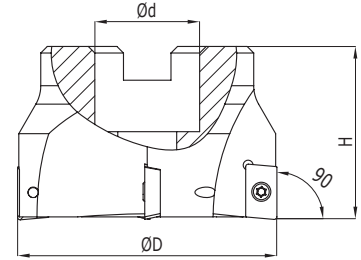



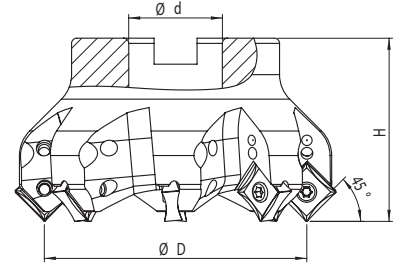

Kesici Uç Uyumluluğu Insert Suitability	Stok Stock	Inter Cooland	D	Z	H	d	APKT		
							Uç Insert	Vida Screw	Anahtar Torx Key
APKT 1604 ISO									
EM90 40X4 016 APKT16	✓	✓	40	4	45	16	AP..1604	M3.5X11	T15
EM90 50X4 022 APKT16	✓	✓	50	4	45	22			
EM90 50X5 022 APKT16	✓	✓	50	5	45	22			
EM90 63X5 022 APKT16	✓	✓	63	5	45	22			
EM90 80X6 027 APKT16	✓	✓	80	6	52	27			
EM90 80X6 032 APKT16	✓	✓	80	6	52	32			
EM90 100X8 032 APKT16	✓	✓	100	8	52	32			
EM90 125X8 040 APKT16	✓	✓	125	8	62	40			
EM90 125X9 040 APKT16	✓	X	125	9	62	40			
EM90 160X10 040 APKT16	✓	X	160	10	62	40			
EM90 200X12 060 APKT16	✓	X	200	12	62	60			

SN..

SN..





Kesici Uç Uyumluluğu Insert Suitability	Stok Stock	Inter Cooland	D	Z	H	d					
							Uç Insert	Vida Screw	Pabuç Clamp	Vida Screw	Anahtar Torx Key
EM45 50X5 022 SN..1206..	✓	✓	50	5	40	22	SN..1206..	M4X12	CK15	M4X12	T15
EM45 63X6 022 SN..1206..	✓	✓	63	6	40	22					
EM45 80X8 027 SN..1206..	✓	✓	80	8	50	27					
EM45 100X10 032 SN..1206..	✓	✓	100	10	50	32					
EM45 125X11 040 SN..1206..	✓	X	125	11	62	40					
EM45 160X12 040 SN..1206..	✓	X	160	12	62	40					

SE..

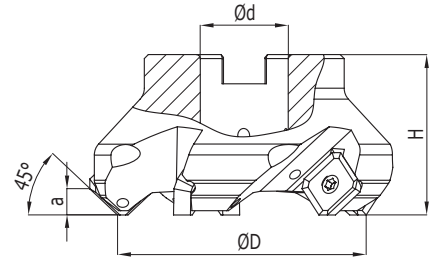
SE..





Kesici Uç Uyumluluğu Insert Suitability	Stok Stock	Inter Cooland	D	Z	H	d			
							Uç Insert	Vida Screw	Anahtar Torx Key
ZCC SNDVK ISO							SEET 12T3	M3,5X11	T15
EM45 50X4 022 SEET 12T3	✓	✓	50	4	40	22			
EM45 63X5 022 SEET 12T3	✓	✓	63	5	40	22			
EM45 80X6 027 SEET 12T3	✓	✓	80	6	50	27			
EM45 100X7 032 SEET 12T3	✓	✓	100	7	50	32			
EM45 125X8 040 SEET 12T3	✓	✓	125	8	62	40			

SE..

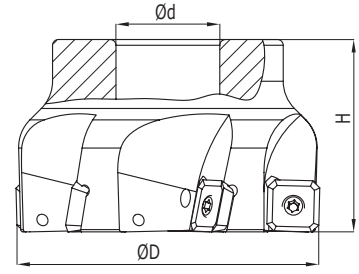
SE..





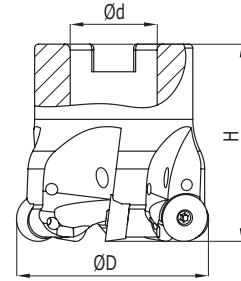

Kesici Uç Uyumluluğu Insert Suitability	Stok Stock	Inter Cooland	D	Z	H	d			
							Uç Insert	Vida Screw	Anahtar Torx Key
ZCC SNDVK ISO									
EM90 50X4 022 SEET 1204	✓	✓	50	4	40	22	SEET 1204	M3,5X11	T15
EM90 63X5 022 SEET 1204	✓	✓	63	5	40	22			
EM90 80X6 027 SEET 1204	✓	✓	80	6	50	27			
EM90 100X7 032 SEET 1204	✓	✓	100	7	50	32			
EM90 125X8 040 SEET 1204	✓	✓	125	8	62	40			

RDKW

RDKW



Kesici Uç Uyumluluğu Insert Suitability	Stok Stock	Inter Cooland	D	Z	H	d						Uç Tipi Insert Type
							Uç Insert	Vida Screw	Pabuç Clamp	Vida Screw	Anahtar Torx Key	
ISO												
EMRC 40X4 016 RD..1003	✓	✓	40	4	40	16	RD..1003..	M3,5X10	CK14	M3,5X8	T15	ISO RD..1003
EMRC 50X5 022 RD..1003	✓	✓	50	5	46	22						
EMRC 63X6 022 RD..1003	✓	✓	63	6	50	22						
EMRC 80X7 027 RD..1003	✓	✓	80	7	52	27						
EMRC 100X8 032 RD..1003	✓	✓	100	8	52	32						
EMRC 40X4 016 RD..1204	✓	✓	40	4	40	16	RD..1204..	M3,5X10	CK14	M3,5X8	T15	ISO RD..1204
EMRC 50X5 022 RD..1204	✓	✓	50	5	46	22						
EMRC 63X6 022 RD..1204	✓	✓	63	6	50	22						
EMRC 80X7 027 RD..1204	✓	✓	80	7	52	27						
EMRC 100X8 032 RD..1204	✓	✓	100	8	52	32						
EMRC 40X4 016 RD..12T3	✓	✓	40	4	40	16	RD..12T3..	M3,5X10	CK14	M3,5X8	T15	ISO RD..12T3
EMRC 50X5 022 RD..12T3	✓	✓	50	5	46	22						
EMRC 63X6 022 RD..12T3	✓	✓	63	6	50	22						
EMRC 80X7 027 RD..12T3	✓	✓	80	7	52	27						
EMRC 100X8 032 RD..12T3	✓	✓	100	8	52	32						
EMRC 63X4 022 RD..1604..	✓	✓	63	4	50	22	RD..1604..	M5X12	TP11	M4X11	T20	ISO RD..1604
EMRC 80X5 027 RD..1604	✓	✓	80	5	52	27						
EMRC 100X6 032 RD..1604	✓	✓	100	6	52	32						
EMRC 125X7 040 RD..1604	✓	✗	125	7	62	40						
EMRC 160X8 040 RD..1604	✓	✗	160	8	62	40						

ANKX..

ANKX..

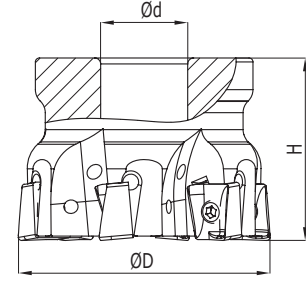

Kesici Uç Uyumluluğu Insert Suitability	Stok Stock	Inter Cooland	D	Z	H	d	Uç Insert	Vida Screw	Anahtar Torx Key
ISCR ANKX 1205..									
EM90 50X5 022 ANKX 1205..	✓	✓	50	5	40	22	ANKX 1205..	M4X11	T15
EM90 63X6 022 ANKX 1205..	✓	✓	63	6	45	22			
EM90 80X7 027 ANKX 1205..	✓	✓	80	7	52	27			
EM90 100X8 032 ANKX 1205..	✓	✓	100	8	52	32			

LNGX 1307

LNGX..

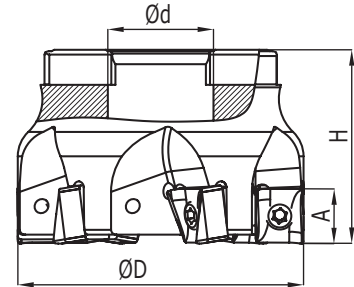



Kesici Uç Uyumluluğu Insert Suitability	Stok Stock	Inter Cooland	D	Z	H	d	Uç Insert	Vida Screw	Anahtar Torx Key
LNGX 1307 WLTR									
EM90 50X3 022 LNGX 1307..	✓	✓	50	3	40	22	LNGX 1307..	M4X11	T15
EM90 63X4 022 LNGX 1307..	✓	✓	63	4	45	22			
EM90 80X5 027 LNGX 1307..	✓	✓	80	5	52	27			
EM90 100X6 032 LNGX 1307..	✓	✓	100	6	52	32			
EM90 125X7 040 LNGX 1307..	X	X	125	7	62	40			
EM90 160X8 040 LNGX 1307..	X	X	160	8	62	40			

LNMX..

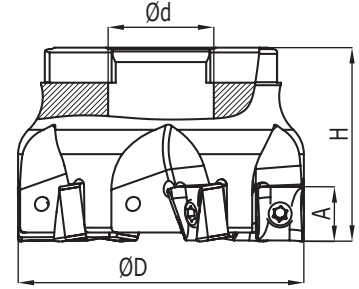
LNMX..





Kesici Uç Uyumluluğu Insert Suitability	Stok Stock	Inter Cooland	D	Z	H	d			
							Uç Insert	Vida Screw	Anahtar Torx Key
KRLY LNMX 1006 LNMX 1510									
EM90 40X4 016 LNMX 1006	✓	✓	40	4	40	16	LNMX 1006..	M3X10	T10
EM90 50X4 022 LNMX 1510	✓	✓	50	4	40	22	LNMX 1510..	M4X11	T15
EM90 63X6 022 LNMX 1510	✓	✓	63	6	40	22			
EM90 80X7 027 LNMX 1510	✓	✓	80	7	52	27			
EM90 100X8 032 LNMX 1510	✓	✓	100	8	52	32			
EM90 125X10 040 LNMX 1510	✓	✗	125	10	62	40			

HN..06

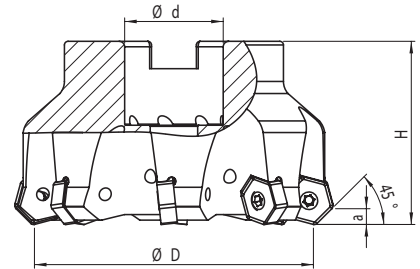
HN..



Kesici Uç Uyumluluğu Insert Suitability	Stok Stock	Inter Cooland	D	Z	H	d			
							Uç Insert	Vida Screw	Anahtar Torx Key
KNMTL HN..0604									
KSHR 50X4 022 HN.. 0604	✓	✓	50	4	40	22	HN.. 0604	M4X12	T15
KSHR 63X6 022 HN.. 0604	✓	✓	63	6	40	22			
KSHR 80X6 027 HN.. 0604	✓	✓	80	6	50	27			
KSHR 100X8 032 HN.. 0604	✓	✓	100	8	50	32			
KSHR 125X10 040 HN.. 0604	✓	✗	125	10	62	40			

HN..09

HN..

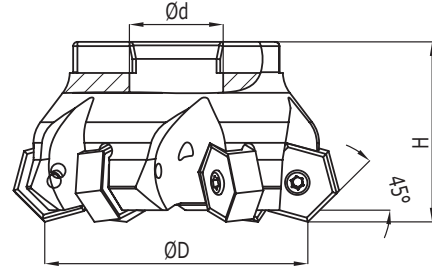

Kesici Uç Uyumluluğu Insert Suitability	Stok Stock	Inter Cooland	D	Z	H	d	Uç Insert	Vida Screw	Anahtar Torx Key
PRMT HN..0906									
EM45 50X4 022 HN..0906	✓	✓	50	4	40	22	HN..0906	M4X12	T15
EM45 63X4 022 HN..0906	✓	✓	63	4	40	22			
EM45 80X6 027 HN..0906	✓	✓	80	6	50	27			
EM45 100X8 032 HN..0906	✓	✓	100	8	50	32			
EM45 125X10 040 HN..0906	✓	X	125	10	62	40			
EM45 160X12 040 HN..0906	✓	X	160	12	62	40			

HNPJ 0704

HNPJ

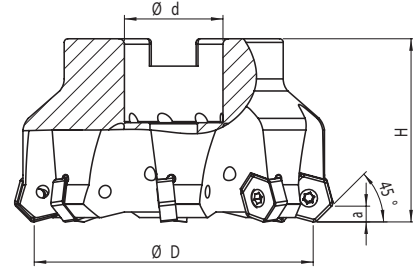



Kesici Uç Uyumluluğu Insert Suitability	Stok Stock	Inter Cooland	D	Z	H	d	Uç Insert	Vida Screw	Anahtar Torx Key
WDA HN..0704									
EM45 50X4 022 HN.. 0704	✓	✓	50	4	40	22	HN.. 0704	M4X12	T15
EM45 63X5 022 HN.. 0704	✓	✓	63	5	40	22			
EM45 80X6 027 HN.. 0704	✓	✓	80	6	50	27			
EM45 100X7 032 HN.. 0704	✓	✓	100	7	50	32			
EM45 125X8 040 HN.. 0704	✓	X	125	8	63	40			
EM45 160X10 040 HN.. 0704	✓	X	160	10	63	40			

ONHU..

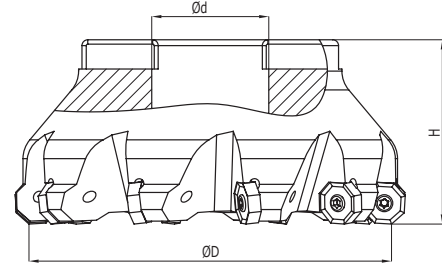
ONHU..





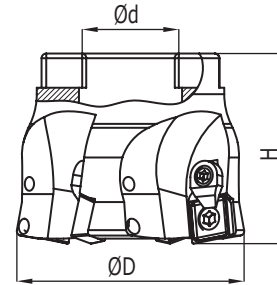

Kesici Uç Uyumluluğu Insert Suitability	Stok Stock	Inter Cooland	D	Z	H	d			
							Uç Insert	Vida Screw	Anahtar Torx Key
ZCC2									
EM45 63X5 022 ONHU 0806	✓	✓	63	5	40	22	ONHU 0806	M4X12	T15
EM45 80X6 027 ONHU 0806	✓	✓	80	6	50	27			
EM45 100X7 032 ONHU 0806	✓	✓	100	7	50	32			
EM45 125X8 040 ONHU 0806	✓	✗	125	8	62	40			
EM45 160X10 040 ONHU 0806	✓	✗	160	10	62	40			

SDMT HIGH FEED MILLING TOOLS

SDMT



Kesici Uç Uyumluluğu Insert Suitability	Stok Stock	Inter Cooland	D	Z	H	d					
							Uç Insert	Vida Screw	Pabuç Clamp	Vida Screw	Anahtar Torx Key
ZCC											
BMR 50X4 022 SDMT 09T3..	✓	✓	50	4	40	22	SDMT 09T3..	M3,5X11	CK14	M3,5X11	T15
BMR 63X5 022 SDMT 09T3..	✓	✓	63	5	40	22					

OFMT 0706

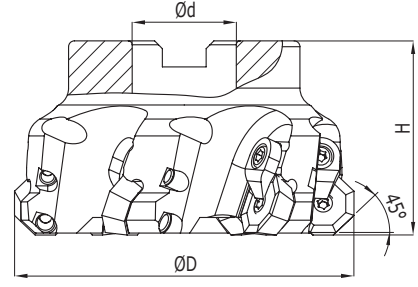

Kesici Uç Uyumluluğu Insert Suitability	Stok Stock	Inter Cooland	D	Z	H	d					
							Uç Insert	Vida Screw	Pabuç Clamp	Vida Screw	Anahtar Torx Key
OFMT 0706.. ISO											
EM45 63X5 022 OFMT 0706..	✓	X	63	5	43	22	OFMT 0706..	M5X12	C110105	M4X12	T20
EM45 80X6 027 OFMT 0706..	✓	X	80	6	50	27					
EM45 100X7 032 OFMT 0706..	✓	X	100	7	50	32					
EM45 125X8 040 OFMT 0706..	✓	X	125	8	62	40					
EM45 160X10 040 OFMT 0706..	✓	X	160	10	62	40					

LNGU 16

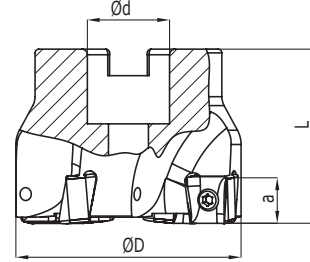

Kesici Uç Uyumluluğu Insert Suitability	Stok Stock	Inter Cooland	D	Z	H	d			
							Uç Insert	Vida Screw	Anahtar Torx Key
LNGU 1607 PRMT									
EM90 63X4 022 LNGU 1607..	X	✓	63	4	45	22	LNGU 1607..	M5X12	T20
EM90 80X4 027 LNGU 1607..	X	✓	80	4	50	27			
EM90 100X5 032 LNGU 1607..	X	✓	100	5	50	32			

LNGX 1205

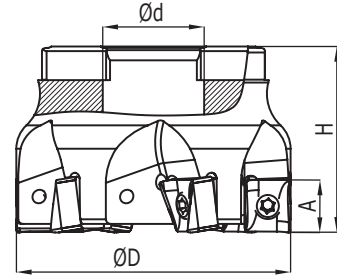

Kesici Uç Uyumluluğu Insert Suitability	Stok Stock	Inter Cooland	D	Z	H	d	Uç Insert	Vida Screw	Anahtar Torx Key
LNGX 1205 PRMT / VNDRT									
EM90 40X4 016 LNGX 1205..	✓	✓	40	4	40	16	LNGX 1205..	M3,5X11	T15
EM90 50X5 022 LNGX 1205..	✓	✓	50	5	40	22			
EM90 63X6 022 LNGX 1205..	✓	✓	63	6	40	22			

ZDCW - ZDEW HIGH FEED MILLING TOOLS

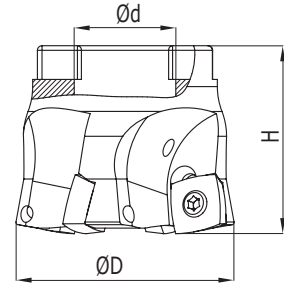

Kesici Uç Uyumluluğu Insert Suitability	Stok Stock	Inter Cooland	D	Z	H	d	Uç Insert	Vida Screw	Pabuç Clamp	Vida Screw	Anahtar Torx Key
PRMT											
BMR 40X4 016 ZDCW 09T304	✓	✓	40	4	40	16	ZDCW 09T304	M4X10	CK14	M4X10	T15
BMR 50X4 022 ZDEW 120408	✓	✓	50	4	40	22	ZDEW 120408				
BMR 63X5 022 ZDEW 120408	✓	✓	63	5	40	22					

WNMX HIGH FEED MILLING TOOLS

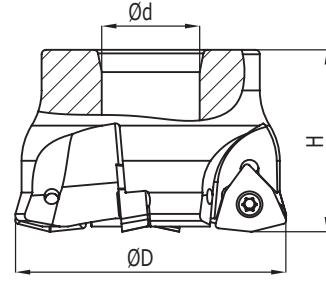

Kesici Uç Uyumluluğu Insert Suitability	Stok Stock	Inter Cooland	D	Z	H	d	Uç Insert	Vida Screw	Anahtar Torx Key
KRLY									
BMR 40X3 016 WNMX 09T316	✓	✓	40	3	40	16	WNMX 09T316	M3X10	T10
BMR 50X4 022 WNMX 09T316	✓	✓	50	4	40	22			
BMR 52X6 022 WNMX 09T316	✓	✓	52	6	40	22			
BMR 50X3 022 WNMX 130520	✓	✓	50	3	40	22	WNMX 130520	M4X10	T15
BMR 63X4 022 WNMX 130520	✓	✓	63	4	40	22			
BMR 80X5 027 WNMX 130520	✓	✓	80	5	50	27			

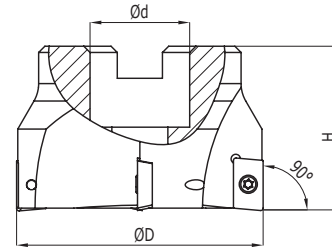

ADKT 1704 SNDVK



Kesici Uç Uyumluluğu Insert Suitability	Stok Stock	Inter Cooland	D	Z	H	d	Uç Insert	Vida Screw	Anahtar Torx Key
ADKT 1704 R390 SNDVK									
EM90 40X4 016 ADKT 1704	X	✓	40	4	40	16	ADKT 1704	M3.5X11	T15
EM90 50X4 022 ADKT 1704	X	✓	50	4	45	22			
EM90 63X5 022 ADKT 1704	X	✓	63	5	45	22			
EM90 80X6 027 ADKT 1704	X	✓	80	6	52	27			

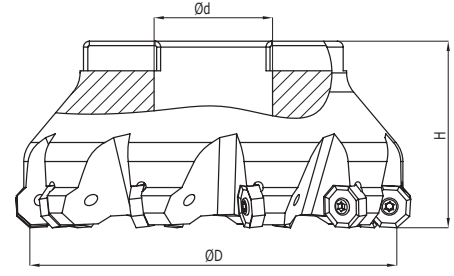

ONMU 0505



Kesici Uç Uyumluluğu Insert Suitability	Stok Stock	Inter Cooland	D	Z	H	d			
							Uç Insert	Vida Screw	Anahtar Torx Key
ON..0505.. ISCR / KLP							ON..0505..	M4,5X12	T20
EM44 50X4 022 ON..0505..	✓	✓	50	4	40	22			
EM44 63X6 022 ON..0505..	✓	✓	63	6	45	22			
EM44 80X7 027 ON..0505..	✓	✓	80	7	52	27			
EM44 100X8 032 ON..0505..	✓	✓	100	8	52	32			
EM44 125X9 040 ON..0505..	✓	X	125	9	62	40			

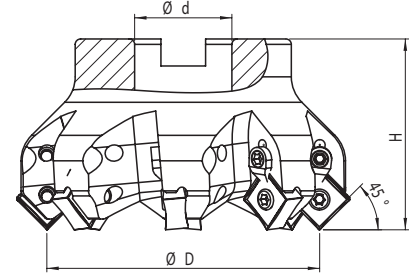

SNMU 1305



Kesici Uç Uyumluluğu Insert Suitability	Stok Stock	Inter Cooland	D	Z	H	d			
							Uç Insert	Vida Screw	Anahtar Torx Key
SN..1305.. ISCR							SN.. 1305..	M4,5X12	T20
EM45 50X4 022 SN..1305..	✓	✓	50	4	40	22			
EM45 63X6 022 SN..1305..	✓	✓	63	6	40	22			
EM45 80X7 027 SN..1305..	✓	✓	80	7	50	27			
EM45 100X8 032 SN..1305..	✓	✓	100	8	50	32			
EM45 125X9 040 SN..1305..	✓	X	125	9	62	40			

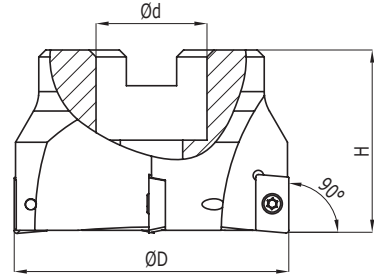

ADMT 1204 WLTR

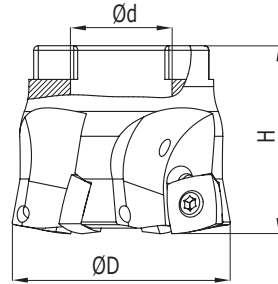

Kesici Uç Uyumluluğu Insert Suitability	Stok Stock	Inter Cooland	D	Z	H	d			
							Uç Insert	Vida Screw	Anahtar Torx Key
ADMT 1204.. WLTR									
EM90 40X4 016 ADMT 1204..	X	✓	40	4	40	16	ADMT 1204..	M3X9	T10
EM90 50X5 022 ADMT 1204..	X	✓	50	5	45	22			
EM90 63X6 022 ADMT 1204..	X	✓	63	6	45	22			

SDMT 1204..



Kesici Uç Uyumluluğu Insert Suitability	Stok Stock	Inter Cooland	D	Z	H	d			
							Uç Insert	Vida Screw	Anahtar Torx Key
ISO									
BMR 52X4 022 SDMT 1204..	X	✓	40	4	40	22	SDMT 1204..	M3,5X10	T15
BMR 66X5 022 SDMT 1204..	X	✓	66	5	45	22			
BMR 80X6 027 SDMT 1204..	X	✓	80	6	50	27			

XNGU 15T6 WDA

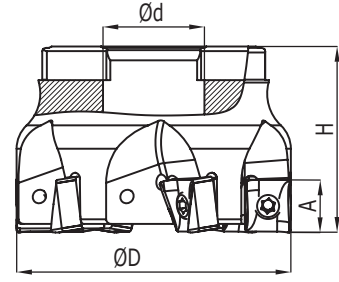

Kesici Uç Uyumluluğu Insert Suitability	Stok Stock								
XNGU 15T6.. KNMTL		Inter Cooland	D	Z	H	d	Uç Insert	Vida Screw	Anahtar Torx Key
EM45 50X5 022 XNGU 15T6..	X	✓	50	5	40	22	XNGU 15T6..	M4X12	T15
EM45 63X5 022 XNGU 15T6..	X	✓	63	5	40	22			
EM45 80X6 027 XNGU 15T6..	X	✓	80	6	50	27			





Siz üretirken biz destek oluyoruz / We support while you produce

MBC www.baydarlar.com

FREZELEME TAKIMLARI- FACE MILLING



TCMT/11/16 S-SİSTEM HAVŞA MATKAPLARI - S-SYSTEM CHAMFERING EN MILLS

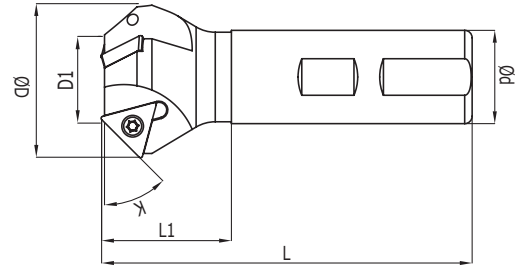

Kesici Uç Uyumluluğu Insert Suitability	Stok Stock	K	D	D1	d	L	L1	Uç Insert	Vida Screw	Anahtar Torx Key
ISO TC.M										
HM 30 D6-20 W16 L100 Z01	✓	30°	20	6	16	L100	35	TC.T 16T3..	M3,5X8	T15
HM 30 D20-35 W16 L100 Z02	✓	30°	35	20	16	L100	35		M3,5X11	T08
HM 30 D24-40 W25 L100 Z02	✓	30°	40	24	25	L100	40			
HM 45 D4-15 W16 L100 Z01	✓	45°	15	4	16	L100	25	TC.T 1102..	M2,5X7	T15
HM 45 D5-23 W16 L100 Z01	✓	45°	23	5	16	L100	35			
HM 45 D10-31 W16 L100 Z02	✓	45°	31	10	16	L100	35	TC.T 16T3..	M3,5X8	T15
HM 45 D14-35 W20 L100 Z02	✓	45°	35	14	20	L100	35			
HM 45 D22-43 W25 L100 Z03	✓	45°	43	22	25	L100	35			
HM 45 D30-50 W25 L100 Z03	✓	45°	50	30	25	L100	45			

DİSK KANAL FREZE - DISC MILLING

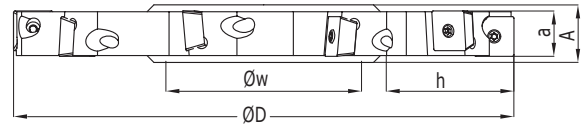

Kesici Uç Uyumluluğu Insert Suitability	Stok Stock	Inter Cooland	D	a	A	Z	h	w	Uç Insert	Vida Screw	Anahtar Torx Key
ISO TC.M											
DKF D80X8 Z10 W27 CC..0602..	✓	X	80	8	12	10	16	27	CC..0602..	M2,5X6	T08
DKF D100X8 Z12 W32 CC..0602..	✓	X	100	8	12	12	24	32			
DKF D125X8 Z14 W40 CC..0602..	✓	X	125	8	12	14	34	40			
DKF D160X8 Z16 W40 CC..0602..	✓	X	160	8	12	16	50	40			
DKF D80X10 Z10 W27 CC..0602..	✓	X	80	10	14	10	16	27			
DKF D100X10 Z12 W32 CC..0602..	✓	X	100	10	14	12	24	32			
DKF D125X10 Z14 W40 CC..0602..	✓	X	125	10	14	14	34	40			
DKF D160X10 Z16 W40 CC..0602..	✓	X	160	10	14	16	50	40			
DKF D80X12 Z8 W27 CC..09T3..	✓	X	80	12	16	8	16	27	CC..09T3..	M3,5X9	T15
DKF D100X12 Z10 W32 CC..09T3..	✓	X	100	12	16	10	24	32			
DKF D125X12 Z12 W40 CC..09T3..	✓	X	125	12	16	12	34	40			
DKF D160X12 Z14 W40 CC..09T3..	✓	X	160	12	16	14	50	40			
DKF D80X14 Z8 W27 CC..09T3..	✓	X	80	14	18	8	16	27			
DKF D100X14 Z10 W32 CC..09T3..	✓	X	100	14	18	10	24	32			
DKF D125X14 Z12 W40 CC..09T3..	✓	X	125	14	18	12	34	40			
DKF D160X14 Z14 W40 CC..09T3..	✓	X	160	14	18	14	50	40			
DKF D80X16 Z6 W27 CC..1204..	✓	X	80	16	20	6	16	27	CC..1204..	M5X10	T20
DKF D100X16 Z8 W32 CC..1204..	✓	X	100	16	20	8	24	32			
DKF D125X16 Z10 W40 CC..1204..	✓	X	125	16	20	10	34	40			
DKF D160X16 Z12 W40 CC..1204..	✓	X	160	16	20	12	50	40			

HELİSEL FREZELER - HELIX FACE MILLING

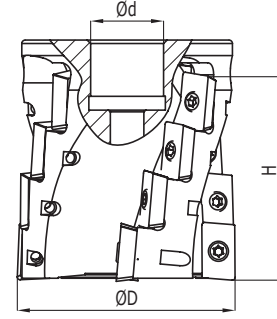

Kesici Uç Uyumluluğu Insert Suitability	Stok Stock
ISO AP..1604..	
HF90 50X3X4 AP..1604..	✓
HF90 63X4X4 AP..1604..	✓
HF90 80X5X5 AP..1604..	✓

Inter Cooland	D	Z	H	d
x	50	12	42	22
x	63	16	56	22
x	80	25	70	27

Uç Insert	Vida Screw	Anahtar Torx Key
AP..1604..	M3.5X8	T15

S-SİSTEM HELİSEL FREZELER - S-SYSTEM HELIX END MILLS

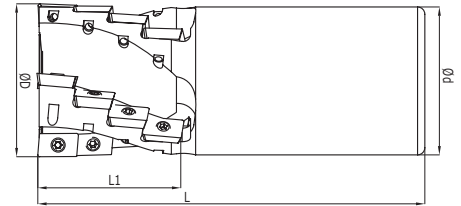

Kesici Uç Uyumluluğu Insert Suitability	Stok Stock
ISO AP..1003..	
HF90 D20 W20 L100 Z2X3 AP.. 1003	✓
HF90 D25 W25 L120 Z2X4 AP.. 1003	✓
HF90 D32 W32 L120 Z3X5 AP.. 1003	✓
HF90 D40 W32 L130 Z3X6 AP.. 1003	✓

Inter Cooland	D	Z	L	L1	d
x	20	6	100	27	20
x	25	8	110	36	25
x	32	15	120	45	32
x	40	18	130	54	32

Uç Insert	Vida Screw	Anahtar Torx Key
AP.. 1003	M2,5X7	T08

AP..

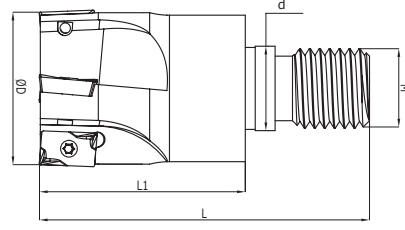

Kesici Uç Uyumluluğu Insert Suitability	Stok Stock	Inter Cooland	D	Z	L1	L	d	M	Uç Insert	Vida Screw	Anahtar Torx Key
VT 25X3 M12 AP..1003..	✓	X	25	3	28	50	12.5	M12	AP..1003..	M2,5X7	T08
VT 32X4 M16 AP..1003..	✓	X	32	4	35	60	17	M16			
VT 35X4 M16 AP..1003..	✓	X	35	4	35	60	17	M16			
VT 40X5 M16 AP..1003..	✓	X	40	5	35	60	17	M16			
VT 42X5 M16 AP..1003..	✓	X	42	5	35	60	17	M16			
VT 25X2 M12 AP..1604..	✓	X	25	2	28	50	12.5	M12	AP..1604..	M3,5X9	T15
VT 32X3 M16 AP..1604..	✓	X	32	3	35	60	17	M16			
VT 40X4 M16 AP..1604..	✓	X	40	4	35	60	17	M16			

RD..

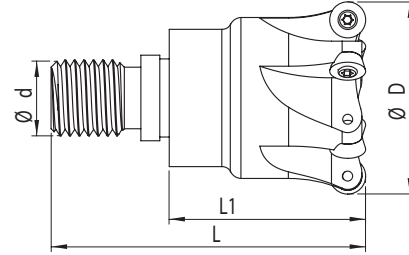

Kesici Uç Uyumluluğu Insert Suitability	Stok Stock	Inter Cooland	D	Z	L1	L	d	M	Uç Insert	Vida Screw	Anahtar Torx Key
VT 25X2 M12 RD..1003..	✓	X	25	2	28	52	12.5	M12	RD..1003..	M3,5X8	T15
VT 25X2 M12 RD..12T3..	✓	X	25	2	28	52	12.5	M12	RD..12T3..		
VT 32X4 M16 RD..1003..	✓	X	32	4	40	64	17	M16	RD..1003..	M5X10	T20
VT 32X3 M16 RD..12T3..	✓	X	32	3	40	64	17	M16	RD..12T3..		
VT 32X2 M16 RD..1604..	✓	X	32	2	40	64	17	M16	RD..1604..	M3,5X8	T15
VT 35X4 M16 RD..1003..	✓	X	35	4	40	64	17	M16	RD..1003..		
VT 35X3 M16 RD..12T3..	✓	X	35	3	40	64	17	M16	RD..12T3..	M5X10	T20
VT 40X2 M16 RD..1604..	✓	X	40	2	40	67	17	M16	RD..1604..		
VT 42X5 M16 RD..1003..	✓	X	42	5	43	67	17	M16	RD..1003..	M3,5X8	T15
VT 42X4 M16 RD..12T3..	✓	X	42	4	43	67	17	M16	RD..12T3..		

WOEJ 0804

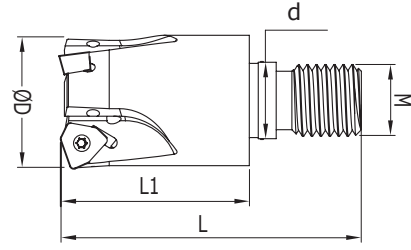

Kesici Uç Uyumluluğu Insert Suitability	Stok Stock	Inter Cooland	D	Z	L1	L	d	M	Uç Insert	Vida Screw	Anahtar Torx Key
WDA											
VT 32X3 M16 WOEJ 0804	x	✓	32	3	41	67	17	M16	WOEJ 0804	M3X9	T10
VT 32X4 M16 WOEJ 0804	x	✓	32	4	41	67	17	M16			
VT 42X4 M16 WOEJ 0804	x	✓	42	4	41	67	17	M16			
VT 42X5 M16 WOEJ 0804	x	✓	42	5	41	67	17	M16			



SP..08T3

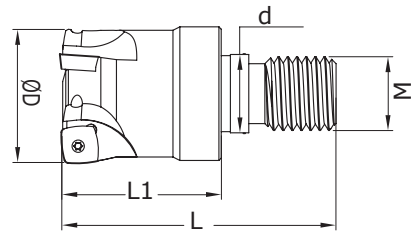

Kesici Uç Uyumluluğu Insert Suitability	Stok Stock	Inter Cooland	D	Z	L1	L	d	M	Uç Insert	Vida Screw	Anahtar Torx Key
PLBT											
VT 25X3 M12 SP..08T308	✓	✓	25	3	28	50	12.5	M12	SP..08T308	M3X10	T10
VT 32X3 M16 SP..08T308	✓	✓	32	3	35	60	17	M16			



SOEW 0803

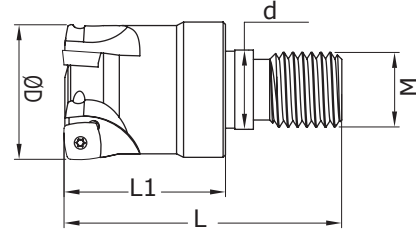

Kesici Uç Uyumluluğu Insert Suitability	Stok Stock	Inter Cooland	D	Z	L1	L	d	M	Uç Insert	Vida Screw	Anahtar Torx Key
PLBT SOEW 0803..									SOEW 0803..	M3X8	T10
VT 32X4 M16 SOEW 0803..	X	✓	32	4	36	60	17	M16			
VT 35X4 M16 SOEW 0803..	X	✓	35	4	36	60	17	M16			
VT 40X5 M16 SOEW 0803..	X	✓	40	5	36	60	17	M16			



DCMT 55° TARAMA KAFASI - 55° FACE MILLING

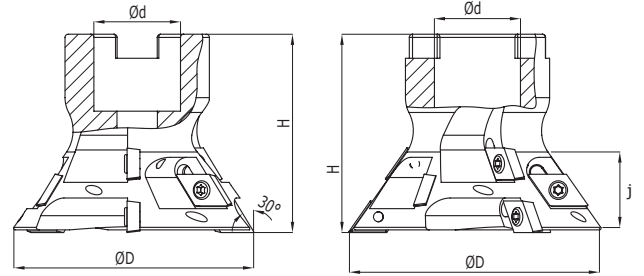

Kesici Uç Uyumluluğu Insert Suitability	Stok Stock	Inter Cooland	D	Z	H	d	j	K	Uç Insert	Vida Screw	Anahtar Torx Key
ISO									DCMT 11T3	M3,5X11	T15
KT-55 80X9 027 DCMT 11	✓	X	80	9	61	27	24	55			
KT-60 50X4 022 DCMT 11	X	X	50	4	45	22	25	60			
KT-60 80X9 027 DCMT 11	✓	X	80	9	61	27	25	60			





U-DRILLER- U-DRILLS



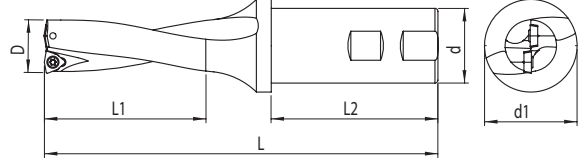



DRILL WCM.. D2

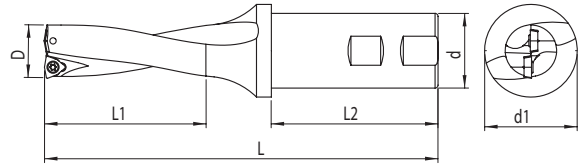

Kesici Uç Uyumluluğu Insert Suitability	Stok Stock	Inter Cooland	D	d	d1	L	L1	L2			
									Uç Insert	Vida Screw	Anahtar Torx Key
MBC DRILL 16XD2 WCM.030208	✓	✓	16	25	34	110	32	50	WCM.030208	M2,5X5	T08
MBC DRILL 17XD2 WCM.030208	✓	✓	17	25	34	112	34	56			
MBC DRILL 18XD2 WCM.030208	✓	✓	18	25	34	114	36	56			
MBC DRILL 19XD2 WCM.030208	✓	✓	19	25	34	116	38	56	WCM.040208	M2,5X5	T08
MBC DRILL 20XD2 WCM.040208	✓	✓	20	25	34	119	40	56			
MBC DRILL 21XD2 WCM.040208	✓	✓	21	25	34	122	42	56			
MBC DRILL 22XD2 WCM.040208	✓	✓	22	25	34	125	44	56	WCM.050308	M3X9	T10
MBC DRILL 23XD2 WCM.040208	✓	✓	23	25	34	128	46	56			
MBC DRILL 24XD2 WCM.050308	✓	✓	24	25	34	129	48	56			
MBC DRILL 25XD2 WCM.050308	✓	✓	25	25	34	131	50	56	WCM.050308	M3X9	T10
MBC DRILL 26XD2 WCM.050308	✓	✓	26	25	34	134	52	56			
MBC DRILL 27XD2 WCM.050308	✓	✓	27	25	34	137	54	56			
MBC DRILL 28XD2 WCM.050308	✓	✓	28	25	34	140	56	56	WCM.06T308	M3,5X9	T15
MBC DRILL 29XD2 WCM.050308	✓	✓	29	25	34	143	58	56			
MBC DRILL 30XD2 WCM.06T308	✓	✓	30	32	44	150	60	60			
MBC DRILL 31XD2 WCM.06T308	✓	✓	31	32	44	153	62	60	WCM.06T308	M3,5X9	T15
MBC DRILL 32XD2 WCM.06T308	✓	✓	32	32	44	156	64	60			
MBC DRILL 33XD2 WCM.06T308	✓	✓	33	32	44	159	66	60			
MBC DRILL 34XD2 WCM.06T308	✓	✓	34	32	44	162	68	60	WCM.06T308	M3,5X9	T15
MBC DRILL 35XD2 WCM.06T308	✓	✓	35	32	44	165	70	60			
MBC DRILL 36XD2 WCM.06T308	x	✓	36	32	44	168	72	60			
MBC DRILL 37XD2 WCM.06T308	x	✓	37	32	44	171	74	60	WCM.06T308	M3,5X9	T15
MBC DRILL 38XD2 WCM.06T308	x	✓	38	32	44	174	76	60			
MBC DRILL 39XD2 WCM.06T308	x	✓	39	32	44	177	78	60			
MBC DRILL 40XD2 WCM.06T308	x	✓	40	32	44	180	80	60	WCM.06T308	M3,5X9	T15
MBC DRILL 41XD2 WCM.06T308	x	✓	41	32	44	183	82	60			
MBC DRILL 42XD2 WCM.06T308	x	✓	42	32	44	186	84	60			
MBC DRILL 43XD2 WCM.06T308	x	✓	43	32	44	189	86	60	WCM.06T308	M3,5X9	T15
MBC DRILL 44XD2 WCM.06T308	x	✓	44	32	44	192	88	60			
MBC DRILL 45XD2 WCM.080412	x	✓	45	40	54	195	90	70			
MBC DRILL 46XD2 WCM.080412	x	✓	46	40	54	198	92	70	WCM.080412	M4X11	T15
MBC DRILL 47XD2 WCM.080412	x	✓	47	40	54	201	94	70			
MBC DRILL 48XD2 WCM.080412	x	✓	48	40	54	204	96	70			
MBC DRILL 49XD2 WCM.080412	x	✓	49	40	54	207	98	70	WCM.080412	M4X11	T15
MBC DRILL 50XD2 WCM.080412	x	✓	50	40	54	210	100	70			



DRILL WCM.. D3



Kesici Uç Uyumluluğu Insert Suitability	Stok Stock	Inter Cooland	D	d	d1	L	L1	L2			
									Uç Insert	Vida Screw	Anahtar Torx Key
MBC DRILL 15.5XD3 WCM.030208	✓	✓	15.5	25	34	126	46.5	56	WCM.030208	M2.5X5	T08
MBC DRILL 16XD3 WCM.030208	✓	✓	16	25	34	126	48	56			
MBC DRILL 16.5XD3 WCM.030208	✓	✓	16.5	25	34	129	49.5	56			
MBC DRILL 17XD3 WCM.030208	✓	✓	17	25	34	129	51	56			
MBC DRILL 17.5XD3 WCM.030208	✓	✓	17.5	25	34	132	52.5	56			
MBC DRILL 18XD3 WCM.030208	✓	✓	18	25	34	135	55.5	56			
MBC DRILL 18.5XD3 WCM.030208	✓	✓	18.5	25	34	135	57	56			
MBC DRILL 19XD3 WCM.030208	✓	✓	19	25	34	139	58.5	56			
MBC DRILL 19.5XD3 WCM.030208	✓	✓	19.5	25	34	139	60	56			
MBC DRILL 20XD3 WCM.040208	✓	✓	20	25	34	143	61.5	56	WCM.040208	M2.5X5	T08
MBC DRILL 20.5XD3 WCM.040208	✓	✓	20.5	25	34	143	63	56			
MBC DRILL 21XD3 WCM.040208	✓	✓	21	25	34	147	64.5	56			
MBC DRILL 21.5XD3 WCM.040208	✓	✓	21.5	25	34	147	66	56			
MBC DRILL 22XD3 WCM.040208	✓	✓	22	25	34	151	67.5	56			
MBC DRILL 22.5XD3 WCM.040208	✓	✓	22.5	25	34	151	69	56			
MBC DRILL 23XD3 WCM.040208	✓	✓	23	25	34	153	70.5	56			
MBC DRILL 23.5XD3 WCM.040208	✓	✓	23.5	25	34	153	72	56	WCM.050308	M3X9	T10
MBC DRILL 24XD3 WCM.050308	✓	✓	24	25	34	156	73.5	56			
MBC DRILL 24.5XD3 WCM.050308	✓	✓	24.5	25	34	156	75	56			
MBC DRILL 25XD3 WCM.050308	✓	✓	25	25	34	160	76.5	56			
MBC DRILL 25.5XD3 WCM.050308	✓	✓	25.5	25	34	160	78	56			
MBC DRILL 26XD3 WCM.050308	✓	✓	26	25	34	164	81	56			
MBC DRILL 27XD3 WCM.050308	✓	✓	27	25	34	168	84	56			
MBC DRILL 28XD3 WCM.050308	✓	✓	28	25	34	172	87	56			
MBC DRILL 29XD3 WCM.050308	✓	✓	29	25	34	180	90	60			
MBC DRILL 30XD3 WCM.06T308	✓	✓	30	32	44	184	93	60			
MBC DRILL 31XD3 WCM.06T308	✓	✓	31	32	44	188	96	60			
MBC DRILL 32XD3 WCM.06T308	✓	✓	32	32	44	192	99	60			
MBC DRILL 33XD3 WCM.06T308	✓	✓	33	32	44	192	102	60			
MBC DRILL 34XD3 WCM.06T308	✓	✓	34	32	44	200	105	60			
MBC DRILL 35XD3 WCM.06T308	✓	✓	35	32	44	204	108	60			
MBC DRILL 36XD3 WCM.06T308	✓	✓	36	32	44	208	111	60			
MBC DRILL 37XD3 WCM.06T308	✓	✓	37	32	44	212	114	60			
MBC DRILL 38XD3 WCM.06T308	✓	✓	38	32	44	216	117	60			
MBC DRILL 39XD3 WCM.06T308	✓	✓	39	32	44	220	120	60			
MBC DRILL 40XD3 WCM.06T308	✓	✓	40	32	44	223	123	60			
MBC DRILL 41XD3 WCM.06T308	✓	✓	41	32	44	226	126	60			
MBC DRILL 42XD3 WCM.06T308	✓	✓	42	32	44	229	129	60			
MBC DRILL 43XD3 WCM.06T308	✓	✓	43	32	44	232	132	60			
MBC DRILL 44XD3 WCM.06T308	✓	✓	44	32	44	245	135	70	WCM.080412	M4X11	T15
MBC DRILL 45XD3 WCM.080412	✓	✓	45	40	54	248	138	70			
MBC DRILL 46XD3 WCM.080412	✓	✓	46	40	54	251	141	70			
MBC DRILL 47XD3 WCM.080412	✓	✓	47	40	54	254	144	70			
MBC DRILL 48XD3 WCM.080412	✓	✓	48	40	54	257	147	70			
MBC DRILL 49XD3 WCM.080412	✓	✓	49	40	54	260	150	70			
MBC DRILL 50XD3 WCM.080412	✓	✓	50	40	54						

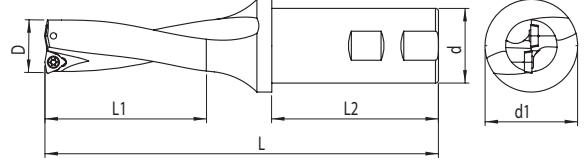

DRILL WCM.. D4



Kesici Uç Uyumluluğu Insert Suitability	Stok Stock	Inter Cooland	D	d	d1	L	L1	L2			
									Uç Insert	Vida Screw	Anahtar Torx Key
MBC DRILL 16XD4 WCM.030208	✓	✓	16	25	34	142	64	56	WCM.030208	M2,5X5	T08
MBC DRILL 17XD4 WCM.030208	✓	✓	17	25	34	146	68	56			
MBC DRILL 18XD4 WCM.030208	✓	✓	18	25	34	150	72	56			
MBC DRILL 19XD4 WCM.030208	✓	✓	19	25	34	154	76	56			
MBC DRILL 20XD4 WCM.040208	✓	✓	20	25	34	159	80	56	WCM.040208	M2,5X5	T08
MBC DRILL 21XD4 WCM.040208	✓	✓	21	25	34	164	84	56			
MBC DRILL 22XD4 WCM.040208	✓	✓	22	25	34	169	88	56			
MBC DRILL 23XD4 WCM.040208	✓	✓	23	25	34	174	92	56			
MBC DRILL 24XD4 WCM.050308	✓	✓	24	25	34	177	96	56	WCM.050308	M3X9	T10
MBC DRILL 25XD4 WCM.050308	✓	✓	25	25	34	181	100	56			
MBC DRILL 26XD4 WCM.050308	✓	✓	26	25	34	186	104	56			
MBC DRILL 27XD4 WCM.050308	✓	✓	27	25	34	191	108	56			
MBC DRILL 28XD4 WCM.050308	✓	✓	28	25	34	196	112	56	WCM.06T308	M3,5X9	T15
MBC DRILL 29XD4 WCM.050308	✓	✓	29	25	34	201	116	56			
MBC DRILL 30XD4 WCM.06T308	✓	✓	30	32	44	210	120	60			
MBC DRILL 31XD4 WCM.06T308	✓	✓	31	32	44	215	124	60			
MBC DRILL 32XD4 WCM.06T308	✓	✓	32	32	44	220	128	60			
MBC DRILL 33XD4 WCM.06T308	✓	✓	33	32	44	225	132	60			
MBC DRILL 34XD4 WCM.06T308	✓	✓	34	32	44	230	136	60			
MBC DRILL 35XD4 WCM.06T308	✓	✓	35	32	44	235	140	60			
MBC DRILL 36XD4 WCM.06T308	✓	✓	36	32	44	238	144	60			
MBC DRILL 37XD4 WCM.06T308	✓	✓	37	32	44	241	148	60			
MBC DRILL 38XD4 WCM.06T308	✓	✓	38	32	44	244	152	60			
MBC DRILL 39XD4 WCM.06T308	✓	✓	39	32	44	247	166	60			
MBC DRILL 40XD4 WCM.06T308	✓	✓	40	32	44	250	160	60			
MBC DRILL 41XD4 WCM.06T308	✓	✓	41	32	44	253	164	60			
MBC DRILL 42XD4 WCM.06T308	✓	✓	42	32	44	256	168	60			
MBC DRILL 43XD4 WCM.06T308	✓	✓	43	32	44	259	172	60			
MBC DRILL 44XD4 WCM.06T308	✓	✓	44	32	44	262	176	60			

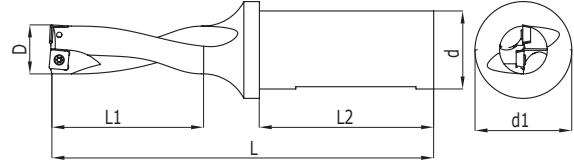

DRILL SPMT.. D2



Kesici Uç Uyumluluğu Insert Suitability	Stok Stock	Inter Cooland	D	d	d1	L	L1	L2			
									Uç Insert	Vida Screw	Anahtar Torx Key
KRLY JD											
MBC DRILL 13XD2 SPMT 050203	X	✓	13	20	25	94	26	50	SPMT 050203	M2X5	T06
MBC DRILL 14XD2 SPMT 050203	X	✓	14	20	25	97	28	50			
MBC DRILL 15XD2 SPMT 050203	X	✓	15	20	25	100	30	50			
MBC DRILL 16XD2 SPMT 060204	X	✓	16	25	34	110	32	50			
MBC DRILL 17XD2 SPMT 060204	X	✓	17	25	34	112	34	56			
MBC DRILL 18XD2 SPMT 060204	X	✓	18	25	34	114	36	56	SPMT 060204	M2.2X5	T06
MBC DRILL 19XD2 SPMT 060204	X	✓	19	25	34	116	38	56			
MBC DRILL 20XD2 SPMT 060204	X	✓	20	25	34	119	40	56			
MBC DRILL 21XD2 SPMT 060204	X	✓	21	25	34	122	42	56	SPMT 070204	M2.5X7	T08
MBC DRILL 22XD2 SPMT 070204	X	✓	22	25	34	125	44	56			
MBC DRILL 23XD2 SPMT 070204	X	✓	23	25	34	128	46	56			
MBC DRILL 24XD2 SPMT 070204	X	✓	24	25	34	129	48	56			
MBC DRILL 25XD2 SPMT 070204	X	✓	25	25	34	131	50	56			

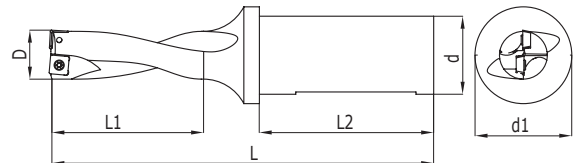

DRILL SPMT.. D3



Kesici Uç Uyumluluğu Insert Suitability	Stok Stock	Inter Cooland	D	d	d1	L	L1	L2			
									Uç Insert	Vida Screw	Anahtar Torx Key
KRLY JD											
MBC DRILL 13XD3 SPMT 050203	✓	✓	13	20	25	101	39	50	SPMT 050203	M2X5	T06
MBC DRILL 14XD3 SPMT 050203	✓	✓	14	20	25	105	42	50			
MBC DRILL 15XD3 SPMT 050203	✓	✓	15	20	25	109	45	50			
MBC DRILL 16XD3 SPMT 060204	✓	✓	16	25	34	126	48	50			
MBC DRILL 17XD3 SPMT 060204	✓	✓	17	25	34	129	51	56			
MBC DRILL 18XD3 SPMT 060204	✓	✓	18	25	34	132	54	56	SPMT 060204	M2.2X5	T06
MBC DRILL 19XD3 SPMT 060204	✓	✓	19	25	34	135	57	56			
MBC DRILL 20XD3 SPMT 060204	✓	✓	20	25	34	139	60	56			
MBC DRILL 21XD3 SPMT 060204	✓	✓	21	25	34	143	63	56	SPMT 070204	M2.5X7	T08
MBC DRILL 22XD3 SPMT 070204	✓	✓	22	25	34	147	66	56			
MBC DRILL 23XD3 SPMT 070204	✓	✓	23	25	34	151	69	56			
MBC DRILL 24XD3 SPMT 070204	✓	✓	24	25	34	153	72	56			
MBC DRILL 25XD3 SPMT 070204	✓	✓	25	25	34	156	75	56			

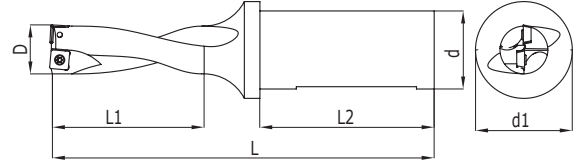

DRILL SPMT.. D4



Kesici Uç Uyumluluğu Insert Suitability	Stok Stock	Inter Cooland	D	d	d1	L	L1	L2			
									Uç Insert	Vida Screw	Anahtar Torx Key
KRLY JD											
MBC DRILL 13XD4 SPMT 050203	x	✓	13	20	25	120	52	50	SPMT 050203	M2X5	T06
MBC DRILL 14XD4 SPMT 050203	x	✓	14	20	25	124	56	50			
MBC DRILL 15XD4 SPMT 050203	x	✓	15	20	25	128	60	50			
MBC DRILL 16XD4 SPMT 060204	✓	✓	16	25	34	142	64	50	SPMT 060204	M2.2X5	T06
MBC DRILL 17XD4 SPMT 060204	✓	✓	17	25	34	146	68	56			
MBC DRILL 18XD4 SPMT 060204	✓	✓	18	25	34	150	72	56			
MBC DRILL 19XD4 SPMT 060204	✓	✓	19	25	34	154	76	56			
MBC DRILL 20XD4 SPMT 060204	✓	✓	20	25	34	159	80	56			
MBC DRILL 21XD4 SPMT 060204	✓	✓	21	25	34	164	84	56			
MBC DRILL 22XD4 SPMT 070204	✓	✓	22	25	34	169	88	56	SPMT 070204	M2.5X7	T08
MBC DRILL 23XD4 SPMT 070204	✓	✓	23	25	34	174	92	56			
MBC DRILL 24XD4 SPMT 070204	✓	✓	24	25	34	177	96	56			
MBC DRILL 25XD4 SPMT 070204	✓	✓	25	25	34	181	100	56			

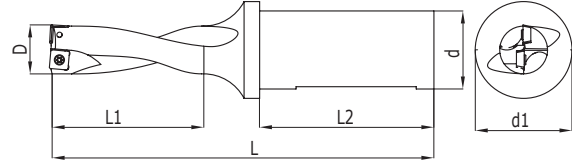

DRILL SP.. D2



Kesici Uç Uyumluluğu Insert Suitability	Stok Stock	Inter Cooland	D	d	d1	L	L1	L2			
									Uç Insert	Vida Screw	Anahtar Torx Key
TGTC / PLBT / ZCC / KLP											
MBC DRILL 13XD2 SP..050204	✓	✓	13	20	25	94	26	50	SP..050204	M2X5	T06
MBC DRILL 14XD2 SP..050204	✓	✓	14	20	25	97	28	50			
MBC DRILL 15XD2 SP..050204	✓	✓	15	20	25	100	30	50			
MBC DRILL 16XD2 SP..060204	✓	✓	16	25	34	110	32	50	SP..060204	M2.2X5	T06
MBC DRILL 17XD2 SP..060204	✓	✓	17	25	34	112	34	56			
MBC DRILL 18XD2 SP..060204	✓	✓	18	25	34	114	36	56			
MBC DRILL 19XD2 SP..060204	✓	✓	19	25	34	116	38	56			
MBC DRILL 20XD2 SP..060204	✓	✓	20	25	34	119	40	56			
MBC DRILL 21XD2 SP..060204	✓	✓	21	25	34	122	42	56			
MBC DRILL 22XD2 SP..07T308	✓	✓	22	25	34	125	44	56	SP..07T308	M2.5X7	T08
MBC DRILL 23XD2 SP..07T308	✓	✓	23	25	34	128	46	56			
MBC DRILL 24XD2 SP..07T308	✓	✓	24	25	34	129	48	56			
MBC DRILL 25XD2 SP..07T308	✓	✓	25	25	34	131	50	56			
MBC DRILL 26XD2 SP..07T308	✗	✗	26	25	34	134	52	56			
MBC DRILL 27XD2 SP..07T308	✗	✗	27	25	34	137	54	56			
MBC DRILL 28XD2 SP..090408	✗	✗	28	25	34	140	56	56	SP..090408	M3,5X8	T15
MBC DRILL 29XD2 SP..090408	✗	✗	29	25	34	143	58	56			
MBC DRILL 30XD2 SP..090408	✗	✗	30	32	44	150	60	60			
MBC DRILL 31XD2 SP..090408	✗	✗	31	32	44	153	62	60			
MBC DRILL 32XD2 SP..090408	✗	✗	32	32	44	156	64	60			
MBC DRILL 33XD2 SP..090408	✗	✗	33	32	44	159	66	60			
MBC DRILL 34XD2 SP..110408	✗	✗	34	32	44	162	68	60	SP..110408	M4X11	T15
MBC DRILL 35XD2 SP..110408	✗	✗	35	32	44	165	70	60			
MBC DRILL 36XD2 SP..110408	✗	✗	36	32	44	168	72	60			
MBC DRILL 37XD2 SP..110408	✗	✗	37	32	44	171	74	60			
MBC DRILL 38XD2 SP..110408	✗	✗	38	32	44	174	76	60			
MBC DRILL 39XD2 SP..110408	✗	✗	39	32	44	177	78	60			
MBC DRILL 40XD2 SP..110408	✗	✗	40	32	44	180	80	60	SP..140512	M5X11	T20
MBC DRILL 41XD2 SP..110408	✗	✗	41	32	44	183	82	60			
MBC DRILL 42XD2 SP..140512	✗	✗	42	32	44	186	84	60			
MBC DRILL 43XD2 SP..140512	✗	✗	43	32	44	189	86	60			
MBC DRILL 44XD2 SP..140512	✗	✗	44	32	44	192	88	60			
MBC DRILL 45XD2 SP..140512	✗	✗	45	40	54	195	90	70			
MBC DRILL 46XD2 SP..140512	✗	✗	46	40	54	198	92	70			
MBC DRILL 47XD2 SP..140512	✗	✗	47	40	54	201	94	70			
MBC DRILL 48XD2 SP..140512	✗	✗	48	40	54	204	96	70			
MBC DRILL 49XD2 SP..140512	✗	✗	49	40	54	207	98	70			
MBC DRILL 50XD2 SP..140512	✗	✗	50	40	54	210	100	70			

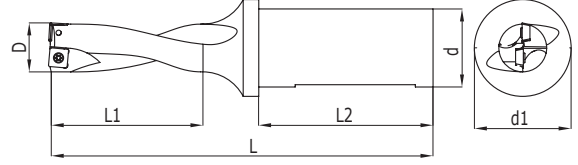

DRILL SP.. D3

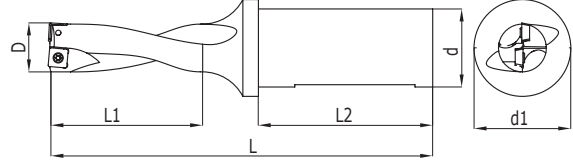

Kesici Uç Uyumluluğu Insert Suitability	Stok Stock	Inter Cooland	D	d	d1	L	L1	L2			
									Uç Insert	Vida Screw	Anahtar Torx Key
TGTC / PLBT / ZCC / KLP											
MBC DRILL 13XD3 SP..050204	✓	✓	13	20	25	101	39	50	SP..050204	M2X5	T06
MBC DRILL 14XD3 SP..050204	✓	✓	14	20	25	105	42	50			
MBC DRILL 15XD3 SP..050204	✓	✓	15	20	25	109	45	50			
MBC DRILL 16XD3 SP..060204	✓	✓	16	25	34	126	48	50	SP..060204	M2.2X5	T06
MBC DRILL 17XD3 SP..060204	✓	✓	17	25	34	129	51	56			
MBC DRILL 18XD3 SP..060204	✓	✓	18	25	34	132	54	56			
MBC DRILL 19XD3 SP..060204	✓	✓	19	25	34	135	57	56			
MBC DRILL 20XD3 SP..060204	✓	✓	20	25	34	139	60	56			
MBC DRILL 21XD3 SP..060204	✓	✓	21	25	34	143	63	56			
MBC DRILL 22XD3 SP..07T308	✓	✓	22	25	34	147	66	56	SP..07T308	M2.5X7	T08
MBC DRILL 23XD3 SP..07T308	✓	✓	23	25	34	151	69	56			
MBC DRILL 24XD3 SP..07T308	✓	✓	24	25	34	153	72	56			
MBC DRILL 25XD3 SP..07T308	✓	✓	25	25	34	156	75	56			
MBC DRILL 26XD3 SP..07T308	✓	✓	26	25	34	160	78	56			
MBC DRILL 27XD3 SP..07T308	✓	✓	27	25	34	164	81	56			
MBC DRILL 28XD3 SP..090408	✓	✓	28	25	34	168	84	56	SP..090408	M3,5X8	T15
MBC DRILL 29XD3 SP..090408	✓	✓	29	25	34	172	87	56			
MBC DRILL 30XD3 SP..090408	✓	✓	30	32	44	180	90	60			
MBC DRILL 31XD3 SP..090408	✓	✓	31	32	44	184	93	60			
MBC DRILL 32XD3 SP..090408	✓	✓	32	32	44	188	96	60			
MBC DRILL 33XD3 SP..090408	✓	✓	33	32	44	192	99	60			
MBC DRILL 34XD3 SP..110408	✓	✓	34	32	44	192	102	60	SP..110408	M4X11	T15
MBC DRILL 35XD3 SP..110408	✓	✓	35	32	44	200	105	60			
MBC DRILL 36XD3 SP..110408	✓	✓	36	32	44	204	108	60			
MBC DRILL 37XD3 SP..110408	✓	✓	37	32	44	208	111	60			
MBC DRILL 38XD3 SP..110408	✓	✓	38	32	44	212	114	60			
MBC DRILL 39XD3 SP..110408	✓	✓	39	32	44	216	117	60			
MBC DRILL 40XD3 SP..110408	✓	✓	40	32	44	220	120	60	SP..140512	M5X11	T20
MBC DRILL 41XD3 SP..110408	x	✓	41	32	44	223	123	60			
MBC DRILL 42XD3 SP..140512	x	✓	42	32	44	226	126	60			
MBC DRILL 43XD3 SP..140512	x	✓	43	32	44	229	129	60			
MBC DRILL 44XD3 SP..140512	x	✓	44	32	44	232	132	60			
MBC DRILL 45XD3 SP..140512	x	✓	45	40	54	235	135	70			
MBC DRILL 46XD3 SP..140512	x	✓	46	40	54	238	138	70			
MBC DRILL 47XD3 SP..140512	x	✓	47	40	54	241	141	70			
MBC DRILL 48XD3 SP..140512	x	✓	48	40	54	244	144	70			
MBC DRILL 49XD3 SP..140512	x	✓	49	40	54	247	147	70			
MBC DRILL 50XD3 SP..140512	x	✓	50	40	54	250	150	70			

DRILL SP.. D4



Kesici Uç Uyumluluğu Insert Suitability	Stok Stock	Inter Cooland	D	d	d1	L	L1	L2			
									Uç Insert	Vida Screw	Anahtar Torx Key
TGTC / PLBT / ZCC / KLP											
MBC DRILL 13XD4 SP..050204	X	✓	13	20	25	120	52	50	SP..050204	M2X5	T06
MBC DRILL 14XD4 SP..050204	X	✓	14	20	25	124	56	50			
MBC DRILL 15XD4 SP..050204	X	✓	15	20	25	128	60	50			
MBC DRILL 16XD4 SP..060204	✓	✓	16	25	34	142	64	50	SP..060204	M2.2X5	T06
MBC DRILL 17XD4 SP..060204	✓	✓	17	25	34	146	68	56			
MBC DRILL 18XD4 SP..060204	✓	✓	18	25	34	150	72	56			
MBC DRILL 19XD4 SP..060204	✓	✓	19	25	34	154	76	56			
MBC DRILL 20XD4 SP..060204	✓	✓	20	25	34	159	80	56			
MBC DRILL 21XD4 SP..060204	✓	✓	21	25	34	164	84	56			
MBC DRILL 22XD4 SP..07T308	✓	✓	22	25	34	169	88	56	SP..07T308	M2.5X7	T08
MBC DRILL 23XD4 SP..07T308	✓	✓	23	25	34	174	92	56			
MBC DRILL 24XD4 SP..07T308	✓	✓	24	25	34	177	96	56			
MBC DRILL 25XD4 SP..07T308	✓	✓	25	25	34	181	100	56			
MBC DRILL 26XD4 SP..07T308	✓	✓	26	25	34	186	104	56			
MBC DRILL 27XD4 SP..07T308	✓	✓	27	25	34	191	108	56			
MBC DRILL 28XD4 SP..090408	✓	✓	28	25	34	196	112	56	SP..090408	M3,5X8	T15
MBC DRILL 29XD4 SP..090408	✓	✓	29	25	34	201	116	56			
MBC DRILL 30XD4 SP..090408	✓	✓	30	32	44	210	120	60			
MBC DRILL 31XD4 SP..090408	✓	✓	31	32	44	215	124	60			
MBC DRILL 32XD4 SP..090408	✓	✓	32	32	44	220	128	60			
MBC DRILL 33XD4 SP..090408	✓	✓	33	32	44	225	132	60			
MBC DRILL 34XD4 SP..110408	✓	✓	34	32	44	230	136	60	SP..110408	M4X11	T15
MBC DRILL 35XD4 SP..110408	✓	✓	35	32	44	235	140	60			
MBC DRILL 36XD4 SP..110408	X	✓	36	32	44	238	144	60			
MBC DRILL 37XD4 SP..110408	X	✓	37	32	44	241	148	60			
MBC DRILL 38XD4 SP..110408	X	✓	38	32	44	244	152	60			
MBC DRILL 39XD4 SP..110408	X	✓	39	32	44	247	156	60			
MBC DRILL 40XD4 SP..110408	X	✓	40	32	44	250	160	60			
MBC DRILL 41XD4 SP..110408	X	✓	41	32	44	253	164	60			

PASO KATERLERİ - STEP CUTTING TOOLS

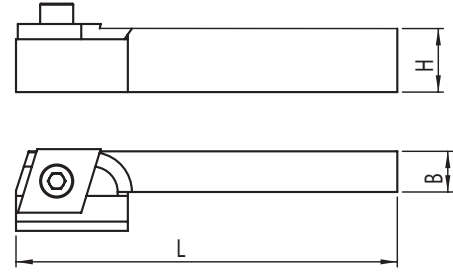
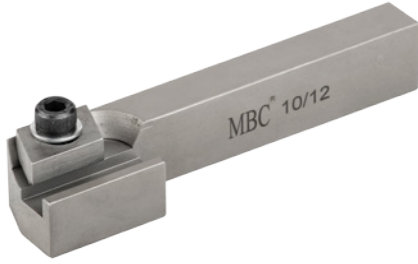

	Stok Stock	H	B	L1	L2	Vida Screw	Anahtar Allen Key
6/8	✓	25	17	45	150	M8X25	A6
8/10	✓	25	17	45	150		
10/12	✓	25	17	45	150		
12/14	✓	25	17	45	150		

KESME KATERLERİ - CUTTING TOOLS

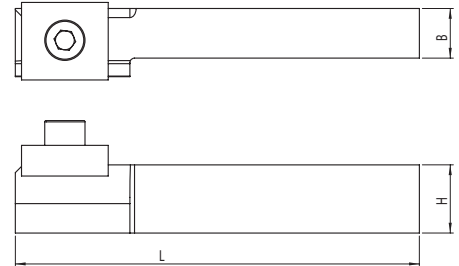

	Stok Stock	H	B	L1	L2	Vida Screw	Anahtar Allen Key
HSS KESME 1"	✓	25	17	45	150	M8X25	A6
HSS KESME 1/2	✓	25	17	45	150		
HSS KESME 3/4	✓	25	17	45	150		
HSS KESME 5/8	✓	22	16	37	150		
HSS KESME 7/8	✓	25	17	46	150		

TIRTIR TEKLİ - SINGLE TOOLS

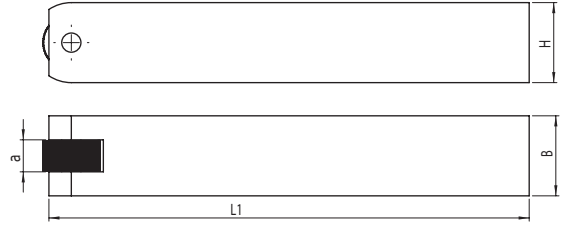

	Stok Stock	B	H	a	L	Pim Pin
10X10 4K	✓	10	10	4	125	4x10
10X10 6K	✓	10	10	6	125	4x10
12X12 4K	✓	12	12	4	125	4x12
12X12 6K	✓	12	12	6	125	4x12
16X16 6K	✓	16	16	6	125	4x16
16X16 8K	✓	16	16	8	125	6x16
20X20 8K	✓	20	20	8	125	6x20
20X20 10K	✓	20	20	10	125	6x20
25X25 8K	✓	25	25	8	150	6x25
25X25 10K	✓	25	25	10	150	6x25

TIRTIR ÇİFTLİ - DOUBLE TOOLS

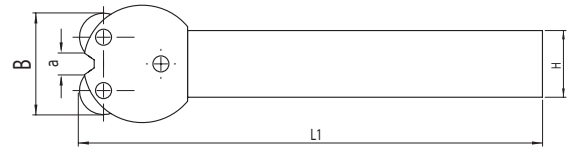

	Stok Stock	B	H	a	L	Pim Pin
22X22 10K	✓	22	22	10	150	6x25

CİVATALAR - SCREWS

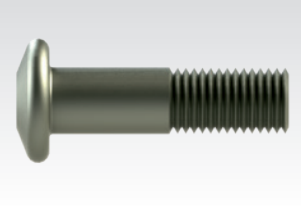

BASKI CİVATALARI

M5X23 A3
M6X27 A3

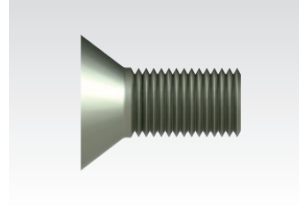

ALTLIK VİDALARI

M3X10
M4X10
M5X10



BUKSE VİDA

M5X0.5X3.5
M6X0.5X4

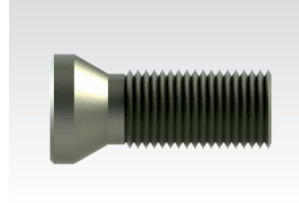

TORX VİDALAR

M2X4
M2X5
M2X6
M2.2X5
M2.2X6
M2.5X5
M2.5X6
M2.5X7
M2.5X8
M2.5X10
M3X6
M3X7
M3X8
M3X10
M3.5X8
M3.5X9
M3.5X10
M3.5X11
M3.5X14
M4X11
M4X12
M4.5X12
M4.5X16
M5X12



BASKI VİDASI

M6X0.75 TPKN 16

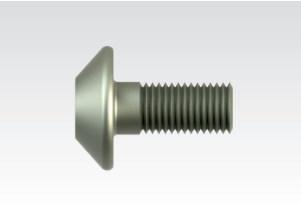

BASKI VİDASI

M8X1 TPKN 22

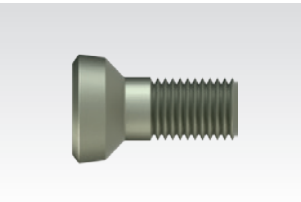

KESME KATER VİDASI

M6X27 A4

KÜRE TAKIM VİDALARI - BALL NOSE SCREWS



KÜRE TAKIM VİDALARI

M3X7 D8
M4X9 D10
M5X10 D12
M5X12 D16
M5X16 D20
M6X22 D25
M8X25 D30

ALTLIKLAR - SHIMS



ALTLIK
DNMG 15
DNMG 11

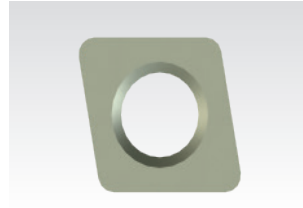

ALTLIK
CNMG 12
CNMG 16
CNMG 19



ALTLIK
TNMG 16
TNMG 22



ALTLIK
WNMG 08



ALTLIK
DCMT 11



ALTLIK
VBMT 16
VCMT 16

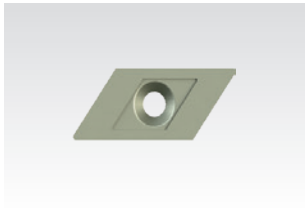

ALTLIK
KNUX 16 SAĞ

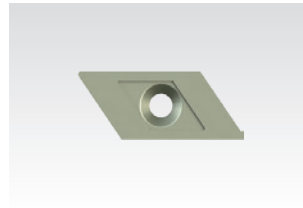

ALTLIK
KNUX 16 SOL



ALTLIK
SIR/SER 16
SIR/SER 22



ALTLIK
SNMG 12
SNMG 15
SNMG 19







ALTLIK
CGMT 12

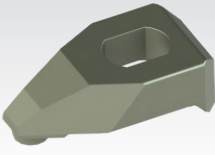
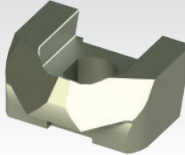
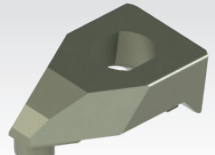
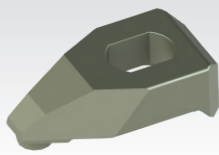
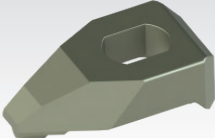
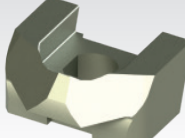
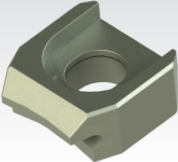
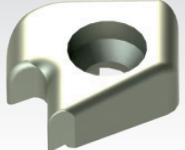
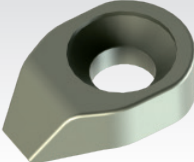
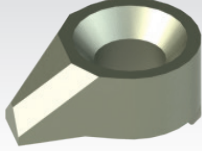

ALTLIK
TCMT 16

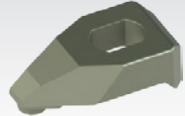
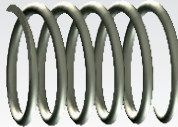
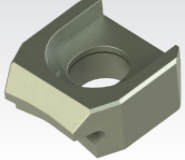
BASKI KEPLERİ - CLAMPS

	BASKI PABUCU T190105 CNMG 19 T190105 SNMG 19		BASKI PABUCU M220105 TNMG 22
	BASKI PABUCU T110105 DNMG 11 T160105 TNMG 16 T060105 WNMG 06		BASKI PABUCU T120105 SNMG 12 T120105 CNMG 12 T150105 DNMG 15 T220105 TNMG 22 T060105 WNMG 08
	BASKI PABUCU T160105 CNMG 16 T160105 SNMG 16		BASKI PABUCU M160105 TNMG 16
	BASKI PABUCU M060105 WNMG 06		BASKI PABUCU C160105 KNUX 16 SAĞ C160105 KNUX 16 SOL C160105 KNUX 16 SOL VE SAĞ
	BASKI PABUCU C110105 TPKN 11 C110105 SNHX 12 C110105 SER/SEL 16 C110105 SER/SEL 22		BASKI PABUCU C160105 TPKN 16
	M SİSTEM ALTLIK PİMİ 5X3.6X15 TNMG 16 5X3.6X15 WNMG 06		BASKI PABUCU C08105 TPKN 16
	BASKI PABUÇ YAYI		BASKI PABUCU M080105 WNMG 08
	M SİSTEM ALTLIK PİMİ 6X5X18 TNMG 22 6X5X18 WNMG 08		BASKI PABUÇ VİDASI PULU 10X6X1 MM

TORNALAMA İÇİN FORMÜLLER - FORMULAS FOR TURNING

$$\text{DEVİR SAYISI} = n = \frac{V_c \times 1000}{\pi \times D} \quad \text{devir / dakika}$$

Revolutions / Umdrehungen Revs / min.
Umdrehungen / min.

n: Devir Sayısı (dev./dak)
Revolutions / Umdrehungen Revs/min.
Umdrehungen/min.

V_c: Kesme Hızı (m./dak.)
Cutting Speed / Schnittgeschwindigkeit (Meter/ Min)

$$\text{KESME HIZI} = V_c = \frac{\pi \times D \times n}{1000} \quad \text{metre / dakika}$$

Cutting speed meter / min.
Schnittgeschwindigkeit

D: İş Parçasının Çapı (mm)
Workpiece diameter / Werkstückdurchmesser

π: Sabit Sayı(3,14)
Constant (3,14) / Gleich bleibend (3,14)

TORNALAMADA İŞLEME ZAMANININ HESAPLANMASI - FORMULAS FOR TURNING TIME

$$\text{Çap Tornalamada} = t_h = \frac{L \times P_s}{n \times f} \quad \text{dakika}$$

Urnng diameter / Drehdurchmesser min.

P_s: Paso Sayısı (kaç defa'da)
no of passes / Durchgänge

t_h: İşleme Zamanı (dakika)
Processing Time / Bearbeitungszeit (min)

f: İlerleme (mm)
Length delivery / Stirn Zustellung (min.)

$$\text{Alın Tornalama} = t_h = \frac{d \times \pi \times L \times P_s}{V_c \times 1000 \times f} \quad \text{dakika}$$

Length turning / Stirn Drehen min.

Alın Tornalama
İçin Boy
Length head turning / Länge für Stirn Drehen

$$L = \frac{d_1 - d_2}{2} \quad \text{mm}$$

Dolu Malzemede
Alın Tornalama
Solid Stock front turning / Massive Werkstücke Stirn Drehen

$$L = \frac{d}{2} \quad \text{mm}$$

YÜZEY FREZELEMEDE KULLANILAN FORMÜLLER - CUTTING RECOMMENDATIONS FOR MILLING

$$\text{DEVİR SAYISI} = n = \frac{V_c \times 1000}{\pi \times D} \quad \text{devir / dakika}$$

Revolutions / Umdrehungen Revs / min.
Umdrehungen / min.

z: Frezenin Ağız Sayısı (adet)
Number of tooth / Anzahl Schneiden

k: Disk Frezenin Efektif Ağız sayısı (adet)
Effective edge of the cutter / Effektive Schneiden des Fräasers

$$\text{KESME HIZI} = V_c = \frac{\pi \times D \times n}{1000} \quad \text{metre / dakika}$$

Revolutions / Umdrehungen meter / min.
Schnittgeschwindigkeit

f_z: Ağız başına ilerleme (mm/ağız)
Delivery per cutting mm / Z / Zustellung pro Schneide mm/Z

t_h: İşleme Zamanı (dak.)
Processing time / Bearbeitungszeit minute

$$\text{TABLA İLERLEMESİ} = V_f = n \times z \times f_z \quad \text{mm/ dak}$$

Delivery / Zustellung mm / min.

P_s: Paso Sayısı
Number of passes / Anzahl der Durchgänge



Organize Sanayi Bölgesi 40 Sk. No:19
Burdur / TÜRKİYE

Tel : +90 248 252 81 15 - 252 81 65

Faks : +90 248 252 99 37

Web : www.baydarlar.com

E-posta : info@baydarlar.om

info@mbckesicitakim.com

Bayii / Reseller